

# 取扱いおよび設置説明書

## Magnetic safety sensor BNS 260-11Z-R 3, 0M

---

### Table of Contents

- 1 About this document
  - 1.1 Function
  - 1.2 Target group of the operating instructions: authorised qualified personnel
  - 1.3 Explanation of the symbols used
  - 1.4 Appropriate use
  - 1.5 General safety instructions
  - 1.6 Warning about misuse
  - 1.7 Exclusion of liability
- 2 Product description
  - 2.1 Ordering code
  - 2.2 Special versions
  - 2.3 Purpose
  - 2.4 Technical Data
- 3 Mounting
  - 3.1 General mounting instructions
  - 3.2 Dimensions
  - 3.3 Axial misalignment
  - 3.4 Adjustment
- 4 Electrical connection
  - 4.1 General information for electrical connection
  - 4.2 Contact Options
  - 4.3 Connector accessories
- 5 Set-up and maintenance
- 6 Disassembly and disposal
  - 6.1 Disassembly
  - 6.2 Disposal

## 1 About this document

### 1.1 Function

This document provides all the information you need for the mounting, set-up and commissioning to ensure the safe operation and disassembly of the switchgear. The operating instructions enclosed with the device must always be kept in a legible condition and accessible.

### 1.2 Target group of the operating instructions: authorised qualified personnel

All operations described in the operating instructions manual must be carried out by trained specialist personnel, authorised by the plant operator only.

Please make sure that you have read and understood these operating instructions and that you know all applicable legislations regarding occupational safety and accident prevention prior to installation and putting the component into operation.

The machine builder must carefully select the harmonised standards to be complied with as well as other technical specifications for the selection, mounting and integration of the components.

The information contained in this operating instructions manual is provided without liability and is subject to technical modifications.

## 1.3 Explanation of the symbols used



**Information, hint, note:** This symbol is used for identifying useful additional information.



**Caution:** Failure to comply with this warning notice could lead to failures or malfunctions.

**Warning:** Failure to comply with this warning notice could lead to physical injury and/or damage to the machine.

## 1.4 Appropriate use

The Schmersal range of products is not intended for private consumers.

The products described in these operating instructions are developed to execute safety-related functions as part of an entire plant or machine. It is the responsibility of the manufacturer of a machine or plant to ensure the correct functionality of the entire machine or plant.

The safety switchgear must be exclusively used in accordance with the versions listed below or for the applications authorised by the manufacturer. Detailed information regarding the range of applications can be found in the chapter "Product description".

## 1.5 General safety instructions

The user must observe the safety instructions in this operating instructions manual, the country specific installation standards as well as all prevailing safety regulations and accident prevention rules.



Further technical information can be found in the Schmersal catalogues or in the online catalogue on the Internet: [products.schmersal.com](http://products.schmersal.com).

## 1.6 Warning about misuse



In case of improper use or manipulation of the safety switchgear, personal hazards or damages to machinery or plant components cannot be excluded. There are no residual risks, provided that the safety instructions as well as the instructions regarding mounting, commissioning, operation and maintenance are observed.

## 1.7 Exclusion of liability

We shall accept no liability for damages and malfunctions resulting from defective mounting or failure to comply with the operating instructions manual. The manufacturer shall accept no liability for damages resulting from the use of unauthorised spare parts or accessories.

For safety reasons, invasive work on the device as well as arbitrary repairs, conversions and modifications to the device are strictly forbidden, the manufacturer shall accept no liability for damages resulting from such invasive work, arbitrary repairs, conversions and/or modifications to the device.

# 2 Product description

## 2.1 Ordering code

Product type description:  
BNS 260-(1) (2) Z(3)-(4)-(5)

(1)	
11	1 NO contacts/1 NC contact
02	2 NC contact

(2)	
without	with diagnostic output
/01	1 NC contact

(3)	
without	without LED switching conditions display
G	with LED switching conditions display

(4)	
without	Pre-wired cable
ST	with connector

(5)	
L	Door hinge on left-hand side
R	Door hinge on right-hand side

## 2.2 Special versions

For special versions, which are not listed in the ordering code, these specifications apply accordingly, provided that they correspond to the standard version.

## 2.3 Purpose

The safety sensor BNS 260 is designed to monitor the position of movable safety guards in safety circuits to EN ISO 14119 and EN 60947-5-3. To actuate the safety sensors, only the BPS 260-1 or BPS 260-2 actuators can be used.

The safety switches are used for applications, in which the hazardous situation is terminated without delay when the safety guard is opened.



The safety switchgears are classified according to EN ISO 14119 as type 4 interlocking devices.

Only the entire system consisting of the BNS 260 safety sensor and the BPS 260-1 or BPS 260-2 actuator and the safety-monitoring module (SRB) meets the requirements of the standard EN 60947-5-3.



The user must evaluate and design the safety chain in accordance with the relevant standards and the required safety level.



The entire concept of the control system, in which the safety component is integrated, must be validated to the relevant standards.

## 2.4 Technical Data

### 認証

証明書	TÜV BG cULus
-----	--------------------

### 一般データ

規格	BG-GS-ET-14 EN IEC 60947-5-3
Coding level according to EN ISO 14119	Low
アクティブ原理	磁気装置
取り付け条件（機械式）	適切な横幅の
ハウジング 材質	グラスファイバー強化熱可塑性樹脂
総重量	121 g

### 一般データ - 仕様

コード化	Yes
NC接点の数	1
NO接点の数	1
安全接点数	2
ケーブルワイヤーの数	4

### 安全性評価

規格	EN ISO 13849-1
Mission time	20 年

### 安全性評価 - 安全出力

B <sub>10D</sub> NC接点	25,000,000 操作
B <sub>10D</sub> □ NC接点/NO接点	25,000,000 操作

### 機械的データ

動作エレメント	ソレノイド
Direction of motion	Head-on to the active surface

### Mechanical data - Switching distances according EN IEC 60947-5-3

Note (Switching distance S <sub>n</sub> )	Axial misalignment, a horizontal and vertical misalignment of the safety sensor and the actuator are tolerated. The possible misalignment depends on the distance of the active surfaces of the sensor and the actuator. The sensor remains active within the tolerance range.
---	--

確実な切替距離「ON」	5 mm
確実な切替距離「OFF」	15 mm

## 機械的データ - 電気機械式

ケーブルの長さ	3 m
端子 コネクター	ケーブル
ケーブル/ワイヤー断面積	0.25 mm <sup>2</sup>
ケーブル径	23 AWG
ケーブルマントルの材質	PVC

## 機械的データ - 寸法

センサー長	13 mm
センサーの幅	26 mm
センサーの高さ	36 mm

## 環境条件

保護等級	IP67
Ambient temperature	-25 ... +70 ° C
Storage and transport temperature	-25 ... +70 ° C
EN 60068-2-6に基づく耐振動	10 ~ 55 Hz, 振幅 1 mm
耐衝撃	30 g / 11 ms

## 環境条件 - 絶縁値

定格絶縁電圧	50 VAC
定格インパルス耐電圧	0.8 kV

## 電気的データ

EN 60947-5-1 に基づく要求定格短絡電流	100 A
開閉電圧、最大	75 VDC
スイッチング電流、最大	0.4 A
開閉容量、最大	10 VA
スイッチ素子	1 NO 接点、1 NC 接点
開閉頻度、最大	5 Hz

## 回路例

Note (Wiring diagram)	The contacts S13-S14 and S21-S22 must be integrated in the safety circuit.
-----------------------	--

### Note about the safety classification

For 2-channel use with suitable logic, can be used up to Cat. 4 / PL e.

$$MTTF_D = \frac{B_{10D}}{0,1 \times n_{op}} \quad n_{op} = \frac{d_{op} \times h_{op} \times 3600 \text{ s/h}}{t_{cycle}}$$

(Determined values can vary depending on the application-specific parameters  $h_{op}$ ,  $d_{op}$  and  $t_{cycle}$  as well as the load.)

If multiple safety components are wired in series, the Performance Level to EN ISO 13849-1 will be reduced due to the restricted error detection under certain circumstances.

#### UL notice



For use in NFPA 79 Applications. Adapters providing field wiring means are available from the manufacturer. Refer to manufacturers information.

## 3 Mounting

### 3.1 General mounting instructions



During fitting, the requirements of EN ISO 14119 must be observed.

- Fitting is only authorised in a de-energised condition
- Do not use the sensor and the actuator as a mechanical backstop
- Any mounting position, provided that the active surfaces are opposite
- Do not subject the safety sensor and actuator to extreme vibrations and shocks

To avoid any interference inherent to this kind of system and any reduction of the switching distances, please observe the following guidelines:

- Ensure the safety sensor is mounted on a flat surface
- Do not install the safety sensor and the actuator in strong magnetic fields
- If possible, do not mount the sensor and the actuator on ferromagnetic material. A non-magnetic spacer of at least 5 mm thick or the original spacer must be used. The use of non-magnetic fixing screws is recommended also.
- Keep away from metal chips
- The mounting distance between two sensors should always be at least 50 mm



The actuator must be permanently fitted to the safety guards and protected against displacement by suitable measures (tamperproof screws, gluing, drilling of the screw heads).

### 3.2 Dimensions

All measurements in mm.

**Sensor with connector, right hinged door**



Safety sensor with cable, left hinged door



Actuator





### 3.3 Axial misalignment

A horizontal and vertical misalignment of the safety sensor and the actuator is tolerated. The possible misalignment depends on the distance of the active surfaces of the sensor and the actuator. The sensor remains active within the tolerance range.

The specified switching distances refer to oppositely mounted safety sensors and actuators.

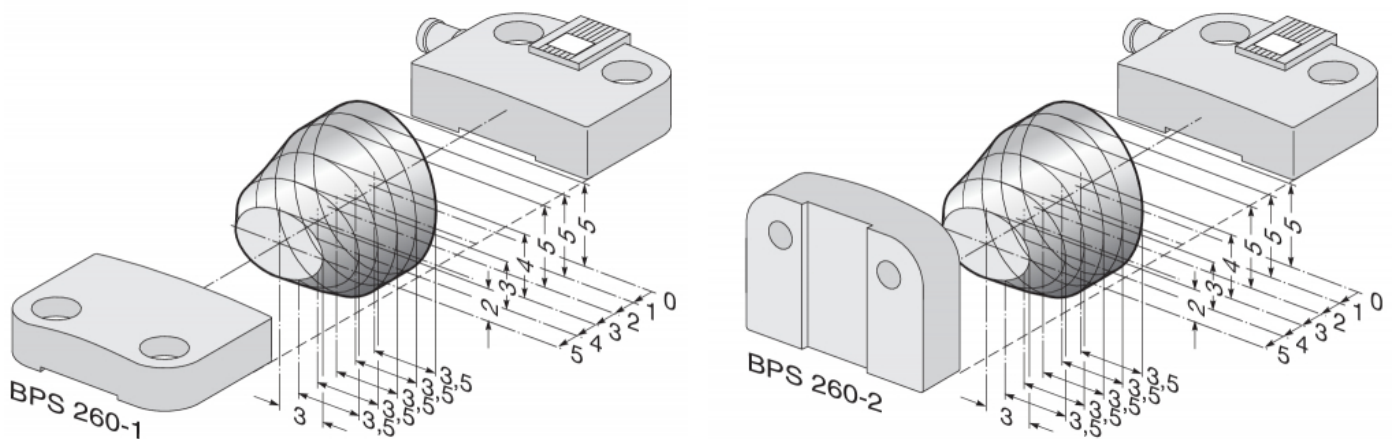

Assured switching distance:	$s_{ao}$	=	5 mm 8 mm (ordering suffix -2750)
Assured switch-off distance:	$s_{ar}$	=	15 mm 18 mm (ordering suffix -2750)

### 3.4 Adjustment



#### Recommended Adjustment

Align the safety sensor and actuator at a distance of  $0.5 \times s_{a0}$ .

Align the central markings of the safety sensor and the actuator with each other. The LED can only be used as rough setting tool. The correct functionality of both safety channels must be checked by means of the connected safety-monitoring module.

## 4 Electrical connection

### 4.1 General information for electrical connection



The electrical connection may only be carried out by authorised personnel in a de-energised condition.

Connecting multiple safety sensors to one SRB safety-monitoring module is technically possible. To connect multiple safety sensors (check if authorised!), their NO contacts are wired in parallel and their NC contacts in series. The Protect-IE-11 or -02 or PROTECT-PE-11 (-AN) or -02 input expander module can be used to connect up to 4 safety sensors with NC/NC or NC/NO contacts.

Safety sensors equipped with LED's shall not be wired in series, except for the PROTECT-IE or PROTECT-PE input expander module. As a result of this, the luminosity of the LEDs would considerably decrease and the voltage could drop below the minimum input voltage of the downstream safety-monitoring module.



Information for the selection of suitable safety-monitoring modules can be found in the Schmersal catalogues or in the online catalogue on the Internet: [products.schmersal.com](http://products.schmersal.com)











### 4.2 Contact Options

The safety sensors must be wired in accordance with the wire colours or the pin configuration.

The contact position shows the actuated sensor function when the safety guard is closed. For safety sensors with LED, the LED is illuminated when the safety guard is closed. The contact configurations of the versions with or without LED are identical.

Safety contacts:	S21-S22 and S11-S12 or S13-S14
Signalling contact:	S31-S32

The numbers between brackets indicate the PIN configuration of the versions with connector plug or connecting cable with connector; indication of the wire colours for the version with cable.

BNS 260-02Z (G)	BNS 260-11Z (G)
(3) BK S11  S12 BU (4) (1) WH S21  S22 BN (2)	(3) BK S13  S14 BU (4) (1) WH S21  S22 BN (2)
BNS 260-02/01Z (G)	BNS 260-11/01Z (G)
(3) GY S11  S12 PK (4) (1) GN S21  S22 YE (2) (5) WH S31  S32 BN (6)	(3) GY S13  S14 PK (4) (1) GN S21  S22 YE (2) (5) WH S31  S32 BN (6)

## 4.3 Connector accessories

Connector plug or cable connector		
		
M8, 4-pole, with screw terminal or snap fitting	8 mm, 6-pole, with snap fitting	M12, 4-pole, screw connection with vibration safeguard

### Accessories: connecting cable with coupling

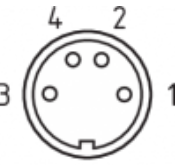
M8, 4-pole, with screw terminal				2 m	5 m	10 m
	1	BN	straight	103011340	103007356	-
	2	WH				
	3	BU	angled	101210557	101210559	-
	4	BK				

8 mm, 6-pole, with snap fitting				2 m	5 m	10 m
	1	GN	straight	101206010	101206011	101206012
	2	YE				
	3	GY				
	4	PK	angled	101206013	101206014	101206015
	5	WH				
	6	BN				

M12, 4-pole, with screw terminal				2 m	5 m	10 m
	1	BN	Straight	103010891	103010892	103010893
	2	WH				
	3	BU				
	4	BK				

Accessory: Y-adapter BNS-Y-11



Accessory: Y-adapter BNS-Y-02

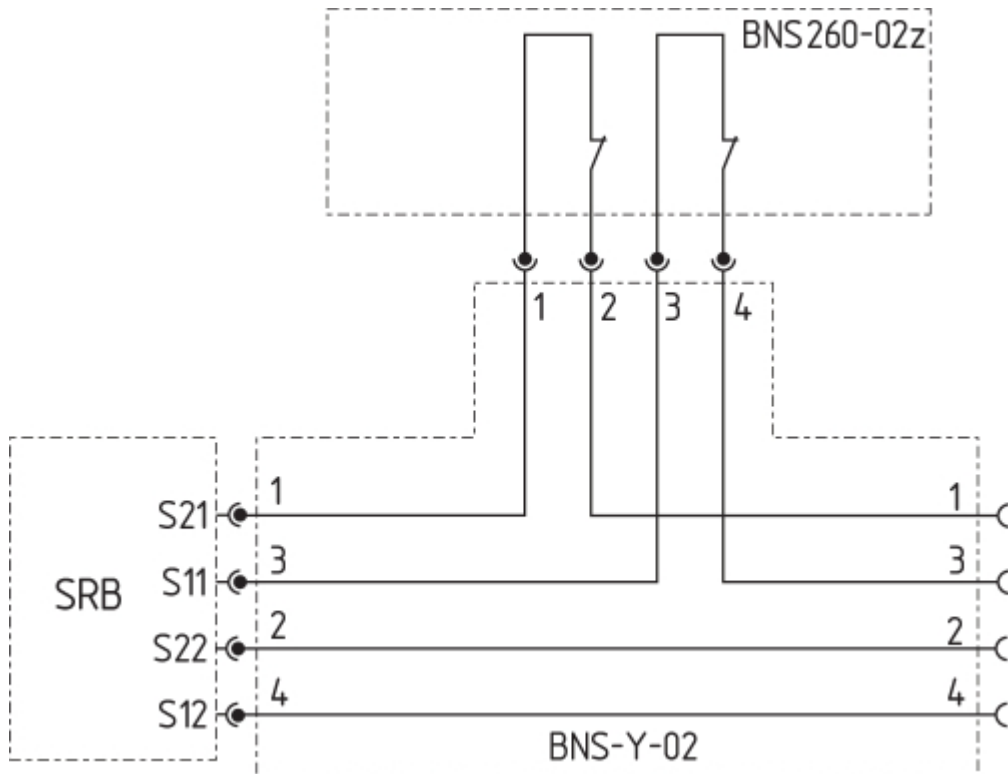

## 5 Set-up and maintenance

The safety function of the safety components must be tested. In the case of correct installation and adequate use, the safety switchgear features maintenance-free functionality. A regular visual inspection and functional test,

including the following steps, is recommended:

1. Check fixation of the safety switch and the actuator.
2. Fitting and integrity of the cable connections.
3. The system is free of dirt and soiling (in particular metal chips).



Adequate measures must be taken to ensure protection against tampering either to prevent tampering of the safety guard, for instance by means of replacement actuators.



Damaged or defective components must be replaced.

## 6 Disassembly and disposal

### 6.1 Disassembly

The safety switchgear must be disassembled in a de-energised condition only.

### 6.2 Disposal



The safety switchgear must be disposed of in an appropriate manner in accordance with the national prescriptions and legislations.