

# INSTRUÇÕES DE OPERAÇÃO E MONTAGEM

## Interruptor de segurança com atuador separado AZ 17-02ZRI B1

---

### Conteúdo

- 1 About this document
  - 1.1 Function
  - 1.2 Target group of the operating instructions: authorised qualified personnel
  - 1.3 Explanation of the symbols used
  - 1.4 Appropriate use
  - 1.5 General safety instructions
- 2 Product description
  - 2.1 Ordering code
  - 2.2 Special versions
  - 2.3 Purpose
  - 2.4 Warning about misuse
  - 2.5 Exclusion of liability
  - 2.6 Technical Data
- 3 Mounting
  - 3.1 General mounting instructions
  - 3.2 Mounting of the actuator
  - 3.3 Dimensions
- 4 Electrical connection
  - 4.1 General information for electrical connection
  - 4.2 Contact Options
- 5 Set-up and maintenance
- 6 Disassembly and disposal
  - 6.1 Disassembly
  - 6.2 Disposal

## 1 About this document

### 1.1 Function

This document provides all the information you need for the mounting, set-up and commissioning to ensure the safe operation and disassembly of the switchgear. The operating instructions enclosed with the device must always be kept in a legible condition and accessible.

### 1.2 Target group of the operating instructions: authorised qualified personnel

All operations described in the operating instructions manual must be carried out by trained specialist personnel, authorised by the plant operator only.

Please make sure that you have read and understood these operating instructions and that you know all applicable legislations regarding occupational safety and accident prevention prior to installation and putting the component into operation.

The machine builder must carefully select the harmonised standards to be complied with as well as other technical specifications for the selection, mounting and integration of the components.

The information contained in this operating instructions manual is provided without liability and is subject to technical modifications.

## 1.3 Explanation of the symbols used



**Information, hint, note:** This symbol is used for identifying useful additional information.



**Caution:** Failure to comply with this warning notice could lead to failures or malfunctions.

**Warning:** Failure to comply with this warning notice could lead to physical injury and/or damage to the machine.

## 1.4 Appropriate use

The Schmersal range of products is not intended for private consumers.

The products described in these operating instructions are developed to execute safety-related functions as part of an entire plant or machine. It is the responsibility of the manufacturer of a machine or plant to ensure the correct functionality of the entire machine or plant.

The safety switchgear must be exclusively used in accordance with the versions listed below or for the applications authorised by the manufacturer. Detailed information regarding the range of applications can be found in the chapter "Product description".

## 1.5 General safety instructions

The user must observe the safety instructions in this operating instructions manual, the country specific installation standards as well as all prevailing safety regulations and accident prevention rules.



Further technical information can be found in the Schmersal catalogues or in the online catalogue on the Internet:

[products.schmersal.com](http://products.schmersal.com).

# 2 Product description

## 2.1 Ordering code

Product type description:  
AZ 17-(1)Z(2)I-(3)-(4)-(5)

(1)

<b>11</b>	1 NO contact/1 NC contact
<b>02</b>	2 NC contact

(2)

<b>without</b>	Latching force 5 N
<b>R</b>	Latching force 30 N

(3)

<b>without</b>	M16 cable gland
<b>ST</b>	M12 connector

(4)

<b>B1</b>	Actuator B1
<b>B5</b>	Actuator B5
<b>B6L</b>	Actuator B6L
<b>B6R</b>	Actuator B6R

(5)

<b>1637</b>	Gold-plated contacts
-------------	----------------------

## 2.2 Special versions

For special versions, which are not listed in the ordering code, these specifications apply accordingly, provided that they correspond to the standard version.

## 2.3 Purpose

The safety switches with separate actuator are suitable for sliding, hinged and removable safety guards, which need to be closed in order to ensure the necessary operational safety.

The safety switches are used for applications, in which the hazardous situation is terminated without delay when the safety guard is opened.

When the safety guard is opened, the NC contacts are positively opened and the NO contacts are closed.



The safety switchgear units are classified as type 2 interlocking devices in accordance with EN ISO 14119 and are rated as highly coded.



The user must evaluate and design the safety chain in accordance with the relevant standards and the required safety level.



The entire concept of the control system, in which the safety component is integrated, must be validated to the relevant standards.

## 2.4 Warning about misuse



In case of improper use or manipulation of the safety switchgear, personal hazards or damages to machinery or plant components cannot be excluded. There are no residual risks, provided that the safety instructions as well as the instructions regarding mounting, commissioning, operation and maintenance are observed.

## 2.5 Exclusion of liability

We shall accept no liability for damages and malfunctions resulting from defective mounting or failure to comply with the operating instructions manual. The manufacturer shall accept no liability for damages resulting from the use of unauthorised spare parts or accessories.

For safety reasons, invasive work on the device as well as arbitrary repairs, conversions and modifications to the device are strictly forbidden, the manufacturer shall accept no liability for damages resulting from such invasive work, arbitrary repairs, conversions and/or modifications to the device.

## 2.6 Technical Data

### Homologações - Instruções

PNV_NORM_CERTIFICATION	cULus
------------------------	-------

### Propriedades globais

NORM_STANDARD	EN ISO 13849-1 EN ISO 14119 EN IEC 60947-5-1
CODE_CODING_LEVEL_ISO14119	Alto
DESIGN_ACTIVE_PRINCIPLE	eletromecânico
MAT_HOUSING	Plástico, termoplástico reforçado com fibra de vidro, auto-extinção de fogo
MAT_ACT	Aço inoxidável
SAP_WEIGHT_GROSS	95

### Propriedades globais - Características

YN_INCREASED_LATCH_FORCE	Sim
--------------------------	-----

NUM_OF_ACT_DIRECTION	2
NUM_OF_SAFE_CONT	2
NUM_OF_CABLE_BUSHING	1

## Classificação

SAFE_NORM_STANDARD	EN ISO 13849-1 EN IEC 60947-5-1
SAFE_PERFORM_LEVEL	c
SAFE_CAT	1
SAFE_B10D_NC	2 000 000
NOTE_SAFE_B10D_NC	Vida útil elétrica sob consulta.
SAFE_MISSION_TIME	20

## Avaliação de segurança - Exclusão de erros

NOTE_SAFE_FAULT_EXCLUSION	Adequado para utilização se uma exclusão de falhas para uma avaria perigosa do canal mecânico 1 for autorizada e uma proteção contra manipulação adequada for assegurada.
SAFE_PERFORM_LEVEL_FAULT_EXCLUSION	d
SAFE_CAT_FAULT_EXCLUSION	3
NOTE_SAFE_CAT_FAULT_EXCLUSION	para utilização de 2 canais e com unidade lógica adequada.
SAFE_MISSION_TIME_FAULT_EXCLUSION	20

## Dados mecânicos

DESIGN_MECH_LIFETIME_SWITCH_MIN	1 000 000
FORCE_LATCH	30
DIM_POSITIVE_BREAK_TRAVEL	11
FORCE_POSITIVE_BREAK_PER_NC_MIN	17
FORCE_POSITIVE_BREAK_MIN	34
MOTION_ACT_SPEED_MAX	2
DESIGN_MOUNTING	parafusos
DESIGN_MOUNTING_SCREW	2x M5
TRQ_TIGHTEN_SCREW_HOUSING_COVER_MIN	0,7
TRQ_TIGHTEN_SCREW_HOUSING_COVER_MAX	1
NOTE_TRQ_TIGHTEN_SCREW_HOUSING_COVER	Torx T10

## Dados mecânicos - Tecnologia conectiva

DESIGN_CABLE_ENTRY	M16 x 1,5
REVIEW_ELEC_WIRING_GENERAL	Método de terminação IDC

ELEC_CABLE_SECTION_MIN	0,75 mm <sup>2</sup>
ELEC_CABLE_SECTION_MAX	1 mm <sup>2</sup>
NOTE_ELEC_CABLE_SECTION	Todas as especificações incluindo ponteiros de cabo.
ELEC_WIRING_EXT_ALLOWABLE	Flexível

## Dados mecânicos - dimensões

DIM_LENGTH_SENSOR	30
DIM_WIDTH_SENSOR	30
DIM_HEIGHT_SENSOR	85

## Ambiente

DESIGN_IP_CLASS_GENERAL	IP67
TEMP_AMB_GPV	-30 ... +80 °C
TEMP_STORAGE_AND_TRANSPORT_GPV	-30 ... +85 °C
DIM_HEIGHT_OPERAT_ALTITUDE_MAX	2 000

## Ambiente - Parâmetros de isolamento

VOLT_RATED_INSULAT	250 VAC
VOLT_RATED_IMPULSE_WITHSTAND	4
DESIGN_OVERVOLT_CAT_IEC60664_1_ROMAN	III
DESIGN_DEG_OF_POLLUT_IEC60664_1	3

## Dados elétricos

CURR_THERMAL_CONTINUOUS	10
CURR_REQUIRED_RATED_SHORT_CIRCUIT	1 000
REVIEW_DESIGN_SWITCH_ELEMENT	2 contactos normalmente fechados (NF)
DESIGN_SWITCH	Comutação de ação lenta, contacto de rutura positiva
TIME_FREQ_OF_OPERAT_MAX	2 000
MAT_CONT_ELEC	Prata

## Dados elétricos - Contactos de segurança

VOLT_UTILISAT_CAT_AC15_SAFE_CONT	230
CURR_UTILISAT_CAT_AC15_SAFE_CONT	4
VOLT_UTILISAT_CAT_DC13_SAFE_CONT	24
CURR_UTILISAT_CAT_DC13_SAFE_CONT	4

## Note about the safety classification

Basically suitable up to Cat. 1 / PL c.

With 2-channel usage with fault exclusion mechanism (if a fault exclusion to the 1-channel mechanics is authorised) and suitable logic applicable up to Cat. 3 / PL d

$$MTTF_D = \frac{B_{10D}}{0,1 \times n_{op}} \quad n_{op} = \frac{d_{op} \times h_{op} \times 3600 \text{ s/h}}{t_{cycle}}$$

(Determined values can vary depending on the application-specific parameters  $h_{op}$ ,  $d_{op}$  and  $t_{cycle}$  as well as the load.)

If multiple safety components are wired in series, the Performance Level to EN ISO 13849-1 will be reduced due to the restricted error detection under certain circumstances.

## 3 Mounting

### 3.1 General mounting instructions



Please observe the remarks of the standards EN ISO 12100, EN ISO 14119 and EN ISO 14120.

The mounting position however must be chosen so that the ingress of dirt and soiling in the used opening is avoided. Use the supplied base plate for the fixing. The tightening torque of the fixing screws must not exceed 150 Ncm. The enclosure must not be used as an end stop. Any position is possible. The mounting position however must be chosen so that the ingress of dirt and soiling in the used opening is avoided. The unused opening must be sealed by means of slot sealing plugs.

### 3.2 Mounting of the actuator



The marks on the used actuator opening of the solenoid interlock and on the actuator must be opposite.



The actuator must be permanently fitted to the safety guards and protected against displacement by suitable measures (tamperproof screws, gluing, drilling of the screw heads).

Please observe that, when fixing the switch e.g. by means of rivetting or welding, the insertion depth of the actuator is not modified. Different actuator forms are available. The actuators B1 and B5 are preferably used for sliding and removable safety guards. For hinged guards, the B6R and B6L actuators.

### Actuator B6L / B6R

When the switch is fitted on a hinged safety guard, please ensure that the point of rotation is located within the range of the upper surface of the safety switch, in which the actuator hook is inserted (refer to table).

Actuating radii [mm]	 over the small edge of the actuator		 over the wide edge of the actuator	
	$R_{min}$	d	$R_{min}$	d
B6L	50	11	50	11
B6R	50	11	50	11

The axis of the hinge must be d mm above and in a parallel plane to the top surface of the safety switch. The basis setting provides a minimum radius of  $R_{min}$ .



The B6L or B6R actuators are set to the smallest radius in factory. To increase the radius, the setting screws a + b must be turned by means of a hexagonal key A/F 2.0 mm.



### 3.3 Dimensions

All measurements in mm.

#### AZ 17 safety switch



**Actuator**

Straight actuator B1

Angled actuator B5

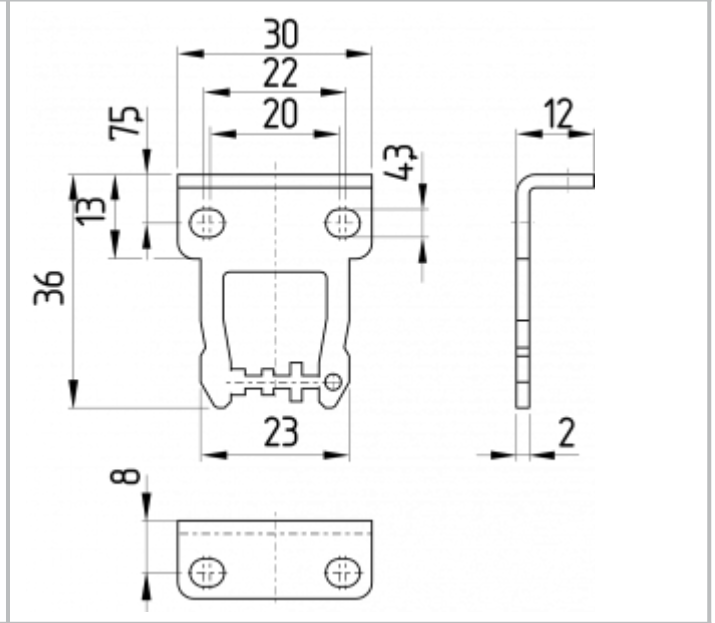
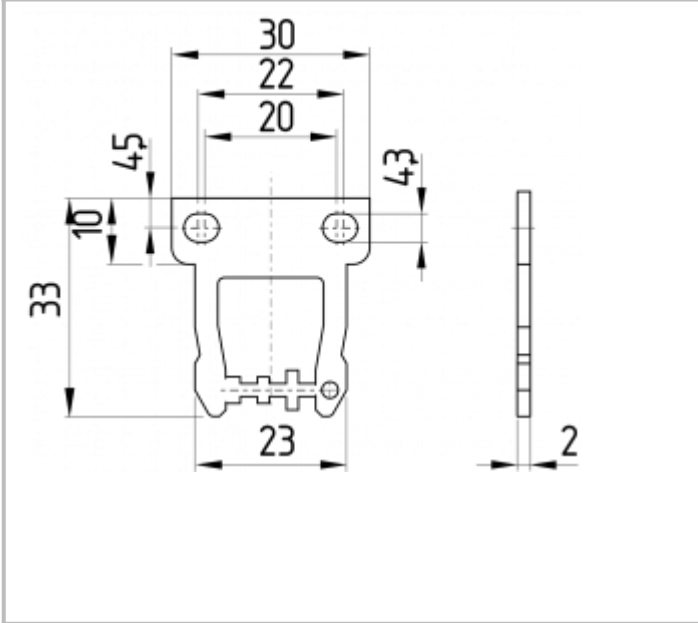

Flexible actuator B6L

Flexible actuator B6R



## 4 Electrical connection

### 4.1 General information for electrical connection



The electrical connection may only be carried out by authorised personnel in a de-energised condition.

The contact labelling can be found in the wiring compartment of the switch. Appropriate cable glands with a suitable degree of protection are to be used.

### IDC method of termination

The IDC method of termination (cut clamp technology) enables connecting flexible wires with cable section 0.75 ... 1 mm<sup>2</sup> without using conductor ferrules. To this effect, strip the wire for 17 ... 20 mm and insert it into the cable gland, close the cable gland, push the conductors in the groove of the cover (refer to wiring example) and screw the cover back. Alternatingly tighten the cover screws uniformly. Tightening force for the Torx T10 cover screws 0.7 ... 1 Nm.



## 4.2 Contact Options

Contacts are shown with safety guard closed. All NC contacts have positive break  $\ominus$ .



with connector, A-coding



Key	
	Automatic opener, NC contact
	Normally-open contact
	Normally-closed contact

## 5 Set-up and maintenance

The safety function of the safety components must be tested. In the case of correct installation and adequate use, the safety switchgear features maintenance-free functionality. A regular visual inspection and functional test, including the following steps, is recommended:

1. Check for correct installation of the actuator and the switch
2. Check the integrity of the cable entry and connections
3. Check the switch enclosure for damages
4. Remove particles of dust and soiling



Adequate measures must be taken to ensure protection against tampering either to prevent tampering of the safety guard, for instance by means of replacement actuators.



Damaged or defective components must be replaced.

## 6 Disassembly and disposal

### 6.1 Disassembly

The safety switchgear must be disassembled in a de-energised condition only.

### 6.2 Disposal



The safety switchgear must be disposed of in an appropriate manner in accordance with the national prescriptions and legislations.