

ÇALIŞTIRMA VE MONTAJ TALIMATLARI

Safety switch with separate actuator AZ 17-02ZRI B1

Table of Contents

- 1 About this document
 - 1.1 Function
 - 1.2 Target group of the operating instructions: authorised qualified personnel
 - 1.3 Explanation of the symbols used
 - 1.4 Appropriate use
 - 1.5 General safety instructions
- 2 Product description
 - 2.1 Ordering code
 - 2.2 Special versions
 - 2.3 Purpose
 - 2.4 Warning about misuse
 - 2.5 Exclusion of liability
 - 2.6 Technical Data
- 3 Mounting
 - 3.1 General mounting instructions
 - 3.2 Mounting of the actuator
 - 3.3 Dimensions
- 4 Electrical connection
 - 4.1 General information for electrical connection
 - 4.2 Contact Options
- 5 Set-up and maintenance
- 6 Disassembly and disposal
 - 6.1 Disassembly
 - 6.2 Disposal

1 About this document

1.1 Function

This document provides all the information you need for the mounting, set-up and commissioning to ensure the safe operation and disassembly of the switchgear. The operating instructions enclosed with the device must always be kept in a legible condition and accessible.

1.2 Target group of the operating instructions: authorised qualified personnel

All operations described in the operating instructions manual must be carried out by trained specialist personnel, authorised by the plant operator only.

Please make sure that you have read and understood these operating instructions and that you know all applicable legislations regarding occupational safety and accident prevention prior to installation and putting the component into operation.

The machine builder must carefully select the harmonised standards to be complied with as well as other technical specifications for the selection, mounting and integration of the components.

The information contained in this operating instructions manual is provided without liability and is subject to technical modifications.

1.3 Explanation of the symbols used



Information, hint, note: This symbol is used for identifying useful additional information.



Caution: Failure to comply with this warning notice could lead to failures or malfunctions.

Warning: Failure to comply with this warning notice could lead to physical injury and/or damage to the machine.

1.4 Appropriate use

The Schmersal range of products is not intended for private consumers.

The products described in these operating instructions are developed to execute safety-related functions as part of an entire plant or machine. It is the responsibility of the manufacturer of a machine or plant to ensure the correct functionality of the entire machine or plant.

The safety switchgear must be exclusively used in accordance with the versions listed below or for the applications authorised by the manufacturer. Detailed information regarding the range of applications can be found in the chapter "Product description".

1.5 General safety instructions

The user must observe the safety instructions in this operating instructions manual, the country specific installation standards as well as all prevailing safety regulations and accident prevention rules.



Further technical information can be found in the Schmersal catalogues or in the online catalogue on the Internet:

products.schmersal.com.

2 Product description

2.1 Ordering code

Product type description:
AZ 17-(1)Z(2)I-(3)-(4)-(5)

(1)

11	1 NO contact/1 NC contact
02	2 NC contact

(2)

without	Latching force 5 N
R	Latching force 30 N

(3)

without	M16 cable gland
ST	M12 connector

(4)

B1	Actuator B1
B5	Actuator B5
B6L	Actuator B6L
B6R	Actuator B6R

(5)

1637	Gold-plated contacts
-------------	----------------------

2.2 Special versions

For special versions, which are not listed in the ordering code, these specifications apply accordingly, provided that they correspond to the standard version.

2.3 Purpose

The safety switches with separate actuator are suitable for sliding, hinged and removable safety guards, which need to be closed in order to ensure the necessary operational safety.

The safety switches are used for applications, in which the hazardous situation is terminated without delay when the safety guard is opened.

When the safety guard is opened, the NC contacts are positively opened and the NO contacts are closed.



The safety switchgear units are classified as type 2 interlocking devices in accordance with EN ISO 14119 and are rated as highly coded.



The user must evaluate and design the safety chain in accordance with the relevant standards and the required safety level.



The entire concept of the control system, in which the safety component is integrated, must be validated to the relevant standards.

2.4 Warning about misuse



In case of improper use or manipulation of the safety switchgear, personal hazards or damages to machinery or plant components cannot be excluded. There are no residual risks, provided that the safety instructions as well as the instructions regarding mounting, commissioning, operation and maintenance are observed.

2.5 Exclusion of liability

We shall accept no liability for damages and malfunctions resulting from defective mounting or failure to comply with the operating instructions manual. The manufacturer shall accept no liability for damages resulting from the use of unauthorised spare parts or accessories.

For safety reasons, invasive work on the device as well as arbitrary repairs, conversions and modifications to the device are strictly forbidden, the manufacturer shall accept no liability for damages resulting from such invasive work, arbitrary repairs, conversions and/or modifications to the device.

2.6 Technical Data

Onaylar

Verileri	cULus
----------	-------

Genel veriler

Normlar, talimatlar	EN ISO 13849-1 EN ISO 14119 EN IEC 60947-5-1
Coding level according to EN ISO 14119	Yüksek
Etkili kural	elektromekanik
Gövdelerin malzemesi	Plastik, fiber cam takviyeli termoplastik kendiliğinden söner
Malzeme, aktüatör	Paslanmaz çelik
Brüt ağırlık	95 g

Genel veriler - Özellikler

Daha etkin Mandallama kuvveti	Evet
-------------------------------	------

Kumanda yönü sayısı	2
Emniyet kontaklarının sayısı	2
Kablo rakorlarının sayısı	1

Güvenlik sınıflandırması

Normlar, talimatlar	EN ISO 13849-1 EN IEC 60947-5-1
Performance Level, up to	c
Kontrol kategorisi EN ISO 13849 e göre	1
B _{10D} Normally-closed contact (NC)	2.000.000 operasyon sayısı
Note	Electrical life on request.
Mission time	20 Yıl(lar)

Güvenlik sınıflandırması - Hata harici tutma

Please note:	Can be used when fault exclusion for dangerous damage to the 1-channel mechanism is permissible and sufficient protection against manipulation is guaranteed.
Performance Level, up to	d
Category	3
Note	for 2-channel use and with suitable logic unit.
Mission time	20 Yıl(lar)

Mekanik veriler

Mekanik ömür, minimum	1.000.000 operasyon sayısı
Mandallama kuvveti	30 N
pozitif fren hareketi	11 mm
Positive break force per NC contact, minimum	17 N
Güç, zorunlu açılma gücü, minimum {N}	34 N
Kumanda hızı, maximum	2 m/s
Montaj	Vidalalar
Type of the fixing screws	2x M5
Tightening torque of the fastening screws for the housing cover, minimum	0,7 Nm
Tightening torque of the fastening screws for the housing cover, maximum	1 Nm
Note	Torx T10

Mekanik veriler - Boyutlar

Kablo girişi	M 16 x 1,5
--------------	------------

Konektör, konektör	IDC sonlandırma metodu
Kablo kesiti, minimum	0,75 mm ²
Kablo kesiti, maximum	1 mm ²
Note	Kablo kısmı hakkındaki bütün göstergeler iletken yüksüklerini dahil ediyor.
Allowed type of cable	flexible

Mekanik veriler - Boyutlar

Sensörün boyu	30 mm
Sensörün genişliği	30 mm
Sensörün yüksekliği	85 mm

Ortam koşulları

Koruma sınıfı	IP67
Ambient temperature	-30 ... +80 °C
Storage and transport temperature	-30 ... +85 °C
Permissible installation altitude above sea level, maximum	2.000 m

Ortam koşulları

Nominal izolasyon gerilimi	250 VAC
Nominal darbeye dayanma gerilimi	4 kV
Overvoltage category	III
Kirlilik derecesi e göre IEC/EN 60664-1	3

Elektriksel veriler

Termal test akımı	10 A
N 60947-5-1 uyarınca koşullu nominal kısa devre akımı	1.000 A
Anahtarlama elemanı	2 Açıcı düzen (NC)
Anahtarlama prensibi	slow action, positive break NC contact
Anahtarlama frekansı	2.000 /h
Malzeme, kontaklar, elektrikli	AgCdO, kendi kendini temizler, pozitif hareket

Elektriksel veriler - Emniyet kontağı

Voltage, Utilisation category AC-15	230 VAC
Current, Utilisation category AC-15	4 A
Voltage, Utilisation category DC-13	24 VDC
Current, Utilisation category DC-13	4 A

Note about the safety classification

Basically suitable up to Cat. 1 / PL c.

With 2-channel usage with fault exclusion mechanism (if a fault exclusion to the 1-channel mechanics is authorised) and suitable logic applicable up to Cat. 3 / PL d

$$MTTF_D = \frac{B_{10D}}{0,1 \times n_{op}} \quad n_{op} = \frac{d_{op} \times h_{op} \times 3600 \text{ s/h}}{t_{cycle}}$$

(Determined values can vary depending on the application-specific parameters h_{op} , d_{op} and t_{cycle} as well as the load.)

If multiple safety components are wired in series, the Performance Level to EN ISO 13849-1 will be reduced due to the restricted error detection under certain circumstances.

3 Mounting

3.1 General mounting instructions



Please observe the remarks of the standards EN ISO 12100, EN ISO 14119 and EN ISO 14120.

The mounting position however must be chosen so that the ingress of dirt and soiling in the used opening is avoided. Use the supplied base plate for the fixing. The tightening torque of the fixing screws must not exceed 150 Ncm. The enclosure must not be used as an end stop. Any position is possible. The mounting position however must be chosen so that the ingress of dirt and soiling in the used opening is avoided. The unused opening must be sealed by means of slot sealing plugs.

3.2 Mounting of the actuator



The marks on the used actuator opening of the solenoid interlock and on the actuator must be opposite.



The actuator must be permanently fitted to the safety guards and protected against displacement by suitable measures (tamperproof screws, gluing, drilling of the screw heads).

Please observe that, when fixing the switch e.g. by means of rivetting or welding, the insertion depth of the actuator is not modified. Different actuator forms are available. The actuators B1 and B5 are preferably used for sliding and removable safety guards. For hinged guards, the B6R and B6L actuators.

Actuator B6L / B6R

When the switch is fitted on a hinged safety guard, please ensure that the point of rotation is located within the range of the upper surface of the safety switch, in which the actuator hook is inserted (refer to table).

Actuating radii [mm]	 over the small edge of the actuator		 over the wide edge of the actuator	
	R_{min}	d	R_{min}	d
B6L	50	11	50	11
B6R	50	11	50	11

The axis of the hinge must be d mm above and in a parallel plane to the top surface of the safety switch. The basis setting provides a minimum radius of R_{min} .

The B6L or B6R actuators are set to the smallest radius in factory. To increase the radius, the setting screws a + b must be turned by means of a hexagonal key A/F 2.0 mm.



3.3 Dimensions

All measurements in mm.

AZ 17 safety switch



Actuator

Straight actuator B1

Angled actuator B5

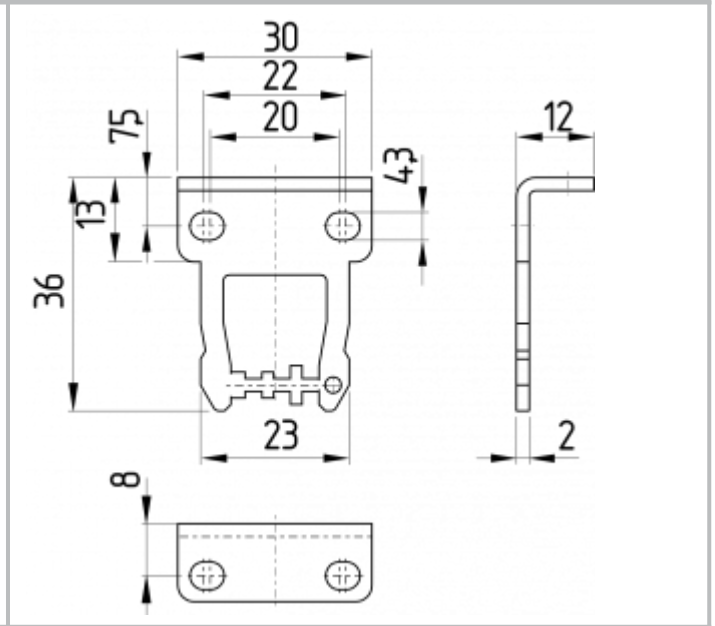
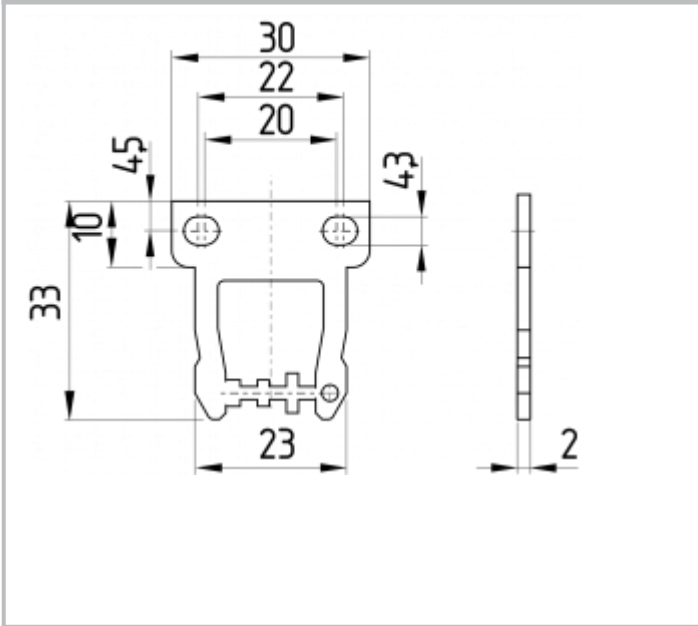

Flexible actuator B6L

Flexible actuator B6R



4 Electrical connection

4.1 General information for electrical connection



The electrical connection may only be carried out by authorised personnel in a de-energised condition.

The contact labelling can be found in the wiring compartment of the switch. Appropriate cable glands with a suitable degree of protection are to be used.

IDC method of termination

The IDC method of termination (cut clamp technology) enables connecting flexible wires with cable section 0.75 ... 1 mm² without using conductor ferrules. To this effect, strip the wire for 17 ... 20 mm and insert it into the cable gland, close the cable gland, push the conductors in the groove of the cover (refer to wiring example) and screw the cover back. Alternatingly tighten the cover screws uniformly. Tightening force for the Torx T10 cover screws 0.7 ... 1 Nm.





4.2 Contact Options

Contacts are shown with safety guard closed. All NC contacts have positive break \ominus .



with connector, A-coding



Key	
	Automatic opener, NC contact
	Normally-open contact
	Normally-closed contact

5 Set-up and maintenance

The safety function of the safety components must be tested. In the case of correct installation and adequate use, the safety switchgear features maintenance-free functionality. A regular visual inspection and functional test, including the following steps, is recommended:

1. Check for correct installation of the actuator and the switch
2. Check the integrity of the cable entry and connections
3. Check the switch enclosure for damages
4. Remove particles of dust and soiling



Adequate measures must be taken to ensure protection against tampering either to prevent tampering of the safety guard, for instance by means of replacement actuators.



Damaged or defective components must be replaced.

6 Disassembly and disposal

6.1 Disassembly

The safety switchgear must be disassembled in a de-energised condition only.

6.2 Disposal



The safety switchgear must be disposed of in an appropriate manner in accordance with the national prescriptions and legislations.