



**EN** Operating instructions. . . . .pages 1 to 6  
Original

**Content**

**1 About this document**

1.1 Function . . . . . 1

1.2 Target group: authorised qualified personnel. . . . . 1

1.3 Explanation of the symbols used . . . . . 1

1.4 Appropriate use . . . . . 1

1.5 General safety instructions . . . . . 1

1.6 Warning about misuse . . . . . 1

1.7 Exclusion of liability . . . . . 2

**2 Product description**

2.1 Ordering code . . . . . 2

2.2 Special versions. . . . . 2

2.3 Purpose . . . . . 2

2.4 Technical data . . . . . 3

2.5 Safety classification of the interlocking function. . . . . 3

2.6 Safety classification of the guard locking function . . . . . 3

**3 Mounting**

3.1 General mounting instructions . . . . . 3

3.2 Dimensions . . . . . 4

**4 Electrical connection**

4.1 General information for electrical connection. . . . . 4

4.2 Contact variants . . . . . 4

4.3 Typical colour code of the Schmersal connector . . . . . 5

**5 Set-up and maintenance**

5.1 Functional testing. . . . . 5

5.2 Maintenance . . . . . 5

**6 Disassembly and disposal**

6.1 Disassembly. . . . . 5

6.2 Disposal . . . . . 5

**7 EU Declaration of conformity**

**1. About this document**

**1.1 Function**

This operating instructions manual provides all the information you need for the mounting, set-up and commissioning to ensure the safe operation and disassembly of the safety switchgear. The operating instructions must be available in a legible condition and a complete version in the vicinity of the device.

**1.2 Target group: authorised qualified personnel**

All operations described in this operating instructions manual must be carried out by trained specialist personnel, authorised by the plant operator only.

Please make sure that you have read and understood these operating instructions and that you know all applicable legislations regarding occupational safety and accident prevention prior to installation and putting the component into operation.

The machine builder must carefully select the harmonised standards to be complied with as well as other technical specifications for the selection, mounting and integration of the components.

**1.3 Explanation of the symbols used**



**Information, hint, note:**

This symbol is used for identifying useful additional information.



**Caution:** Failure to comply with this warning notice could lead to failures or malfunctions.

**Warning:** Failure to comply with this warning notice could lead to physical injury and/or damage to the machine.

**1.4 Appropriate use**

The products described in these operating instructions are developed to execute safety-related functions as part of an entire plant or machine. It is the responsibility of the manufacturer of a machine or plant to ensure the correct functionality of the entire machine or plant.

The safety switchgear must be exclusively used in accordance with the versions listed below or for the applications authorised by the manufacturer. Detailed information regarding the range of applications can be found in the chapter "Product description".

**1.5 General safety instructions**

The user must observe the safety instructions in this operating instructions manual, the country specific installation standards as well as all prevailing safety regulations and accident prevention rules.



Further technical information can be found in the Schmersal catalogues or in the online catalogue on the Internet: [www.schmersal.net](http://www.schmersal.net).

The information contained in this operating instructions manual is provided without liability and is subject to technical modifications. There are no residual risks, provided that the safety instructions as well as the instructions regarding mounting, commissioning, operation and maintenance are observed.

**1.6 Warning about misuse**



In case of improper use or manipulation of the safety switchgear, personal hazards or damages to machinery or plant components cannot be excluded. The relevant requirements of the standard ISO 14119 must be observed.

### 1.7 Exclusion of liability

We shall accept no liability for damages and malfunctions resulting from defective mounting or failure to comply with this operating instructions manual. The manufacturer shall accept no liability for damages resulting from the use of unauthorised spare parts or accessories.

For safety reasons, invasive work on the device as well as arbitrary repairs, conversions and modifications to the device are strictly forbidden; the manufacturer shall accept no liability for damages resulting from such invasive work, arbitrary repairs, conversions and/or modifications to the device.

## 2. Product description

### 2.1 Ordering code

This operating instructions manual applies to the following types:

#### AZM 170<sup>①</sup>-<sup>②</sup>Z<sup>③</sup>K<sup>④</sup>-<sup>⑤</sup>-<sup>⑥</sup>-024

No.	Option	Description
①	SK	Screw terminals
	ST	M12 x 1 connector
②	12 / 11	Magnet: 1NO 1NC / Actuator: 1NO 1NC
	12 / 02	Magnet: 1NO 2NC / Actuator: 2NC
	12 / 00	Magnet: 1NO 2NC / Actuator: –
	11 / 11	Magnet: 1NO 1NC / Actuator: 1NO 1NC
	11 / 02	Magnet: 1NO 1NC / Actuator: 2NC
	02 / 10	Magnet: 2NC / Actuator: 1NO
	02 / 01	Magnet: 2NC / Actuator: 1NC
③		Latching force 5 N
	R	Latching force 30 N
④		Power to unlock
	A	Power to lock
⑤	1637	gold-plated contacts
⑥	2197	Manual release for Power to unlock
	2405	Emergency exit



Only if the information described in this operating instructions manual are realised correctly, the safety function and therefore the compliance with the Machinery Directive is maintained.

### 2.2 Special versions

For special versions, which are not listed in the order code below 2.1, these specifications apply accordingly, provided that they correspond to the standard version.

### 2.3 Purpose

The solenoid interlock AZM 170 has been designed to prevent movable safety guards in conjunction with the control part of a machine from being opened before hazardous conditions have been eliminated.



The safety switchgears are classified according to ISO 14119 as type 2 switching devices.



Interlocks with power to lock principle may only be used in special cases after a thorough evaluation of the accident risk, since the safety guard can be opened immediately on failure of the power supply or upon activation of the main switch.

### Manual release

A manual release is available as a mounting tool and in the event of a power failure in case the power to unlock principle is used. If the triangular key is turned 180°, the locking bolt is pulled into the unlocking position. Please ensure that jamming by external influence on the actuator is avoided. The normal locking function is only restored after the triangular key has been returned to its original position. After being put into operation, the manual release must be secured by installing the sealing plug, which is included in delivery.

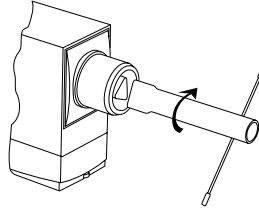

Triangular key TK-M5 (101100887) available as accessory.

### Emergency exit

Fitting and actuation only from within the hazardous area.

To activate the emergency exit, turn the red lever in the direction of the arrow to the end stop. Please ensure that jamming by external influence on the actuator is avoided.



The user must evaluate and design the safety chain in accordance with the relevant standards and the required safety level.



The entire concept of the control system, in which the safety component is integrated, must be validated to the relevant standards.

### 2.4 Technical data

Standards:	IEC 60947-5-1, ISO 14119
Enclosure:	glass-fibre reinforced thermoplastic, self-extinguishing
Actuator and locking bolt:	stainless steel 1.4301
Holding force F:	1,000 N
Latching force:	5 N
- Ordering suffix R:	30 N
Coding level according to ISO 14119:	low
Protection class:	IP67
Contact material:	Silver
Contact type:	change-over contact with double break, type Zb, with galvanically separated contact bridges
Switching system:	⊖ acc. IEC 60947-5-1 slow action, NC contact with positive break
Cable entry:	M20 x 1.5
Connection:	Screw terminals or connector
Cable type:	Flexible with insulated conductor ferrules
Cable section:	min. 0.25 mm <sup>2</sup> , max. 1.5 mm <sup>2</sup> (including conductor ferrules)
Rated impulse withstand voltage U <sub>imp</sub> :	4 kV
- Connector:	0.8 kV
Rated insulation voltage U <sub>i</sub> :	250 V
- Connector:	60 V
Positive break travel:	11 mm
Positive break force:	8.5 N for each NC contact fitted
Actuating speed:	max. 2 m/s
Actuating frequency:	max. 1,000 operations/h
Mechanical life:	> 1,000,000 operations
Ambient temperature:	-25 °C ... +60 °C
<b>Electrical data:</b>	
Utilisation category:	DC-13
Rated operating current/voltage I <sub>e</sub> /U <sub>e</sub> :	4 A / 24 VDC
- Connector:	2 A / 24 VDC
Thermal test current I <sub>the</sub> :	6 A
- Connector:	2 A
Max. fuse rating:	6 A gG D-fuse
- Connector:	2 A gG D-fuse
Required rated short-circuit current:	1,000 A
<b>Electrical data – Magnet control:</b>	
Duty ratio solenoid:	100 %
Rated control voltage U <sub>s</sub> :	24 VDC
Power consumption:	max. 12 W
Accepted test pulse duration on input signal:	≤ 5.0 ms
- With test pulse interval of:	≥ 50 ms

### 2.5 Safety classification of the interlocking function

Standards:	ISO 13849-1
Envisaged structure:	
- Basically:	applicable up to Cat. 1 / PL c
- With 2-channel usage and fault exclusion mechanism*:	applicable up to Cat. 3 / PL d with suitable logic unit
B <sub>10D</sub> NC contact:	2,000,000
B <sub>10D</sub> NO contact at 10% ohmic contact load:	1,000,000
Mission time:	20 years
* If a fault exclusion to the 1-channel mechanics is authorised.	

$$MTTF_D = \frac{B_{10D}}{0,1 \times n_{op}} \quad n_{op} = \frac{d_{op} \times h_{op} \times 3600 \text{ s/h}}{t_{cycle}}$$

(Determined values can vary depending on the application-specific parameters h<sub>op</sub>, d<sub>op</sub> and t<sub>cycle</sub> as well as the load.)

If multiple safety components are wired in series, the Performance Level to ISO 13849-1 will be reduced due to the restricted error detection under certain circumstances.

### 2.6 Safety classification of the guard locking function

If the device is used as an interlock for personal safety, a safety classification of the guard locking function is required.

When classifying the interlock function, a distinction must be made between monitoring of the interlock function (locking function) and controlling the unlocking function.

The following safety classification of the unlocking function is based on the application of the principle of safety energy disconnection for the solenoid supply.



The classification of the unlocking function is only valid for devices with monitored guard locking function and in the power to unlock version (see ordering code).

A fault exclusion for the locking device of the solenoid interlock can be assumed by a safety external energy disconnection.

In this case, the locking device of the solenoid interlock does not have an effect on the failure probability of the unlock function.

The safety level of the unlock function is determined exclusively by the external safety power shutdown.

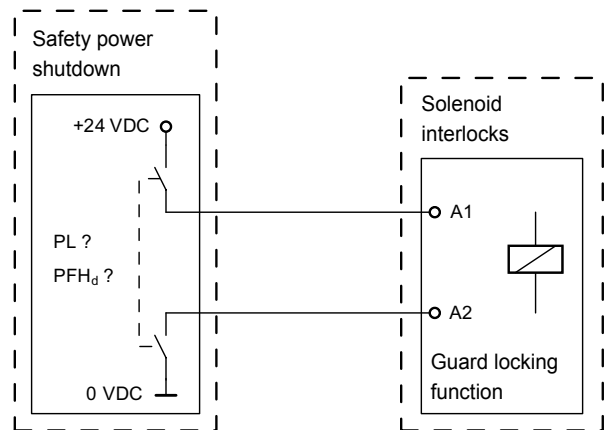

Fault exclusion with regard to wiring routing must be observed.



If for a certain application the quiescent current version of a solenoid interlock cannot be used, for this exception an interlock with power to lock can be used if additional safety measure need to be realised that have an equivalent safety level.

## 3. Mounting

### 3.1 General mounting instructions

Two mounting holes are provided for fixing the enclosure. The solenoid interlock is double insulated. The use of an earth wire is not authorised. The solenoid interlock must not be used as an end stop. Any mounting position. The mounting position must be chosen so as to avoid the penetration of dirt in the used holes. The unused opening must be sealed by means of slot sealing plugs. Tightening force for the Torx T10 cover screws 0.7 ... 1 Nm.



Please observe the relevant requirements of the standards ISO 12100, ISO 14119 and ISO 14120.



The actuator must be permanently fitted to the safety guards and protected against displacement by suitable measures (tamperproof screws, gluing, drilling of the screw heads).

## 3.2 Dimensions

All measurements in mm.

### AZM 170SK with screw terminals and cable entry

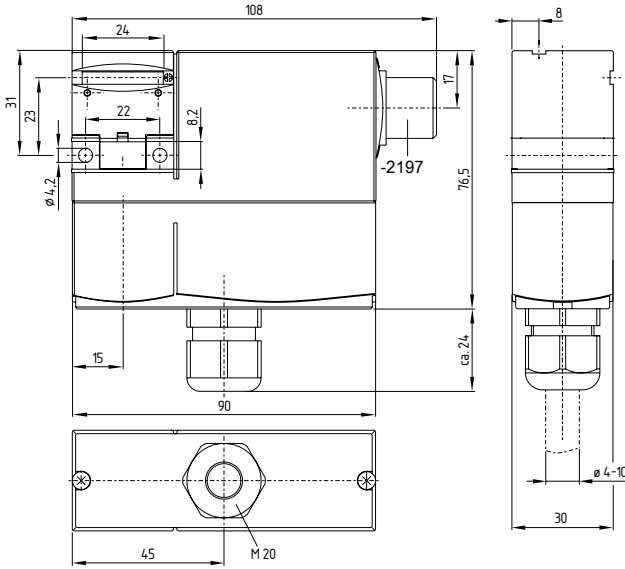

**KEY:** Manual release from side, ordering suffix -2197

### AZM 170ST with connectors

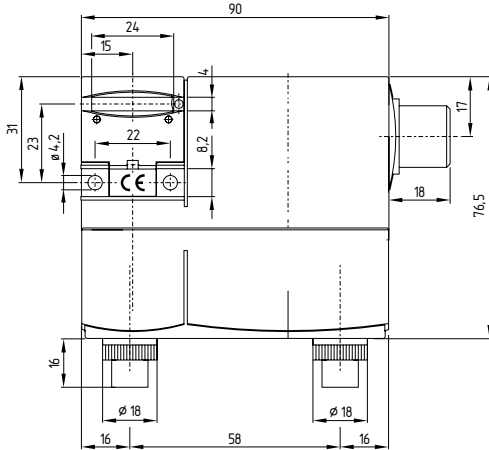

## 4. Electrical connection

### 4.1 General information for electrical connection



The electrical connection may only be carried out by authorised personnel in a de-energised condition.



If the risk analysis indicates the use of a monitored interlock they are to be connected in the safety circuit with the contacts indicated with the symbol

Appropriate cable glands with a suitable degree of protection are to be used.



Information for the selection of suitable safety-monitoring modules can be found in the Schmersal catalogues or in the online catalogue on the Internet: [www.schmersal.net](http://www.schmersal.net).

## 4.2 Contact variants

Contacts shown in a de-energised condition and with the actuator inserted.

### AZM 170 SK with screw terminals and cable entry

#### Power to unlock

**1 NO 2 NC**  
(Ordering suffix - 12 / 00)

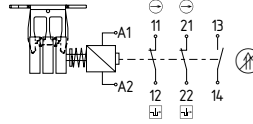

11 12 21 22 13 14 A1 A2

**2 NC / 1 NC**  
(Ordering suffix - 02 / 01)

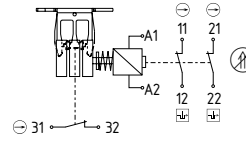

11 12 21 22 31 32 A1 A2

**2 NC / 1 NO**  
(Ordering suffix - 02 / 10)

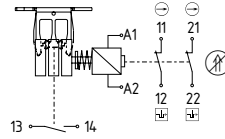

11 12 21 22 13 14 A1 A2

**1 NO 1 NC / 1 NO 1 NC**  
(Ordering suffix - 11 / 11)

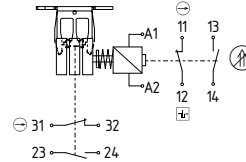

11 12 13 14 23 24 31 32 A1 A2

**1 NO 1 NC / 2 NC**  
(Ordering suffix - 11 / 02)

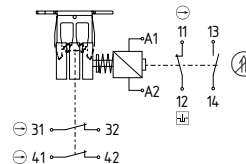

11 12 13 14 31 32 41 42 A1 A2

#### Power to lock

**1 NO 2 NC**  
(Ordering suffix - 12 / 00)

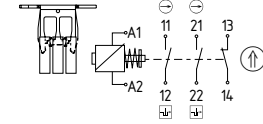

11 12 21 22 13 14 A1 A2

**2 NC / 1 NC**  
(Ordering suffix - 02 / 01)

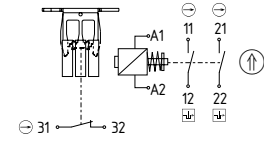

11 12 21 22 31 32 A1 A2

**2 NC / 1 NO**  
(Ordering suffix - 02 / 10)

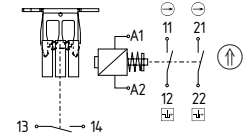

11 12 21 22 13 14 A1 A2

**1 NO 1 NC / 1 NO 1 NC**  
(Ordering suffix - 11 / 11)

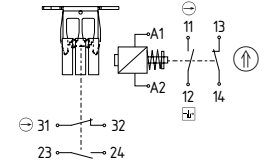

11 12 13 14 23 24 31 32 A1 A2

**1 NO 1 NC / 2 NC**  
(Ordering suffix - 11 / 02)

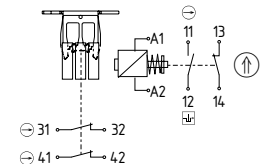

11 12 13 14 31 32 41 42 A1 A2

#### Key

- Positive break NC contact
- Monitoring the interlock according to ISO 14119
- Actuated
- Not actuated

### AZM 170ST with M12 connectors - 8 and 4-pole

#### Power to unlock

**1 NO 2 NC / 2 NC**  
(Ordering suffix - 12 / 02)

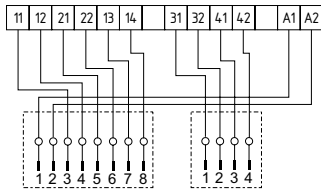
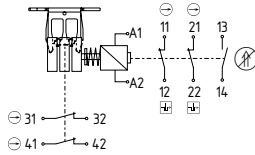

#### Power to lock

**1 NO 2 NC / 2 NC**  
(Ordering suffix - 12 / 02)

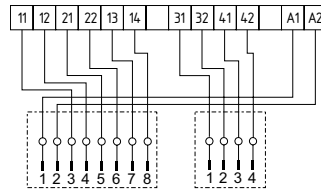
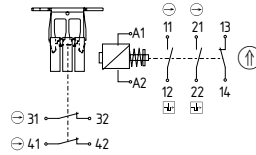

**1 NO 2 NC / 1 NO 1 NC**  
(Ordering suffix - 12 / 11)

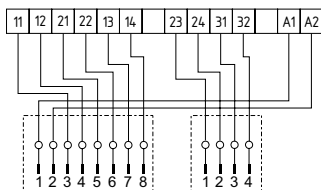
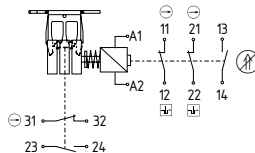

**1 NO 2 NC / 1 NO 1 NC**  
(Ordering suffix - 12 / 11)

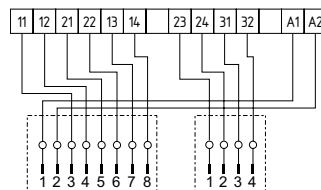
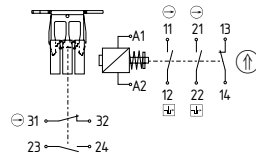

**1 NO 1 NC / 1 NO 1 NC**  
(Ordering suffix - 11 / 11)

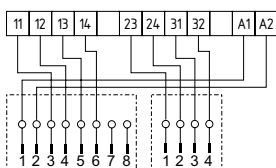
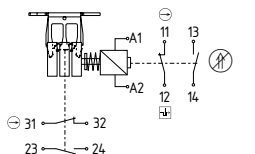

**1 NO 1 NC / 1 NO 1 NC**  
(Ordering suffix - 11 / 11)

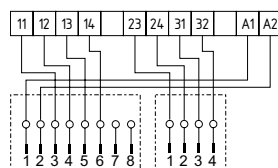
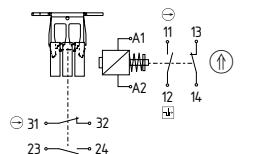

**1 NO 1 NC / 2 NC**  
(Ordering suffix - 11 / 02)

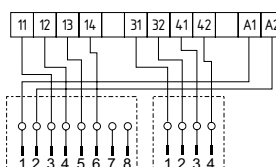
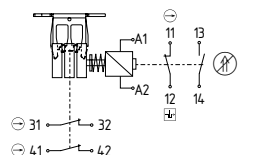

**1 NO 1 NC / 2 NC**  
(Ordering suffix - 11 / 02)

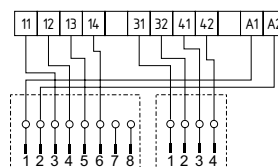
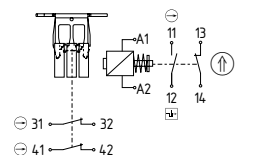

### AZM 170ST with connector 12, 8-pole

#### Power to unlock

**2 NC / 1 NC**  
(Ordering suffix - 02 / 01)

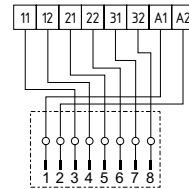
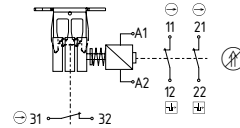

#### Power to lock

**2 NC / 1 NC**  
(Ordering suffix - 02 / 01)

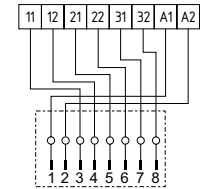
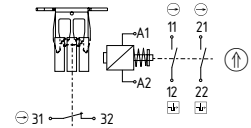

#### 4.3 Typical colour code of the Schmersal connector

##### M12, 4-pole

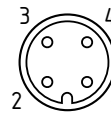

PIN 1: BN  
PIN 2: WH  
PIN 3: BU  
PIN 4: BK

##### M12, 8-pole

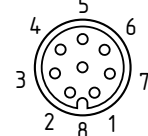

PIN 1: WH  
PIN 2: BN  
PIN 3: GN  
PIN 4: YE  
PIN 5: GY  
PIN 6: PK  
PIN 7: BU  
PIN 8: RD

Further information for available connectors can be found on our website: [www.schmersal.net](http://www.schmersal.net).

### 5. Set-up and maintenance

#### 5.1 Functional testing

The safety function of the safety components must be tested. The following conditions must be previously checked and met:

1. Fitting of the solenoid interlock and the actuator
2. Check the integrity of the cable entry and connections
3. Check the switch enclosure for damage

#### 5.2 Maintenance

A regular visual inspection and functional test, including the following steps, is recommended:

1. Check for tight installation of the actuator and the switch
2. Remove particles of dust and soiling
3. Check cable entry and connections



Adequate measures must be taken to ensure protection against tampering either to prevent tampering of the safety guard, for instance by means of replacement actuators.

**Damaged or defective components must be replaced.**

### 6. Disassembly and disposal

#### 6.1 Disassembly

The safety switchgear must be disassembled in a de-energised condition only.

#### 6.2 Disposal

The safety switchgear must be disposed of in an appropriate manner in accordance with the national prescriptions and legislations.

7. EU Declaration of conformity

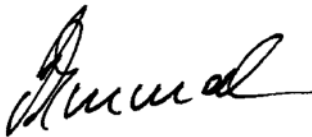
<b>EU Declaration of conformity</b>			
Original	K.A. Schmersal GmbH & Co. KG Möddinghofe 30 42279 Wuppertal Germany Internet: www.schmersal.com		
We hereby certify that the hereafter described components both in their basic design and construction conform to the applicable European Directives.			
<b>Name of the component:</b>	AZM 170		
<b>Type:</b>	See ordering code		
<b>Description of the component:</b>	Interlocking device with electromagnetic interlock for safety functions		
<b>Relevant Directives:</b>		Valid up to	Valid as of
		April 19, 2016	April 20, 2016
	Machinery Directive	2006/42/EC	2006/42/EG
	EMC-Directive	2004/108/EG	2014/30/EU
	RoHS-Directive	2011/65/EU	2011/65/EU
<b>Applied standards:</b>	DIN EN 60947-5-1:2010 DIN EN ISO 14119:2014		
<b>Person authorised for the compilation of the technical documentation:</b>	Oliver Wacker Möddinghofe 30 42279 Wuppertal		
<b>Place and date of issue:</b>	Wuppertal, March 7, 2016		
			
	Authorised signature <b>Philip Schmersal</b> Managing Director		

AZM170-E-EN



The currently valid declaration of conformity can be downloaded from the internet at [www.schmersal.net](http://www.schmersal.net).

