



EN Operating instructions.pages 1 to 8
Original

Content

1 About this document

1.1 Function 1

1.2 Target group: authorised qualified personnel. 1

1.3 Explanation of the symbols used 1

1.4 Appropriate use 1

1.5 General safety instructions 1

1.6 Warning about misuse 2

1.7 Exclusion of liability 2

2 Product description

2.1 Ordering code 2

2.2 Special versions. 2

2.3 Purpose 2

2.4 Technical data 2

2.5 Classification 3

3 Mounting

3.1 General mounting instructions 3

3.2 Dimensions 3

4 Electrical connection

4.1 General information for electrical connection. 3

5 Operating principle and settings

5.1 LED functions. 3

5.2 Description of the terminals 4

5.3 Notes 5

5.4 Setting report SRB324ST V.3 5

6 Set-up and maintenance

6.1 Functional testing. 5

6.2 Maintenance 5

7 Disassembly and disposal

7.1 Disassembly. 5

7.2 Disposal 5

8 Appendix

8.1 Wiring examples 5

8.2 Start configuration 6

8.3 Sensor configuration 6

8.4 Actuator configuration 7

9 EU Declaration of conformity

1. About this document

1.1 Function

This operating instructions manual provides all the information you need for the mounting, set-up and commissioning to ensure the safe operation and disassembly of the safety-monitoring module. The operating instructions must be available in a legible condition and a complete version in the vicinity of the device.

1.2 Target group: authorised qualified personnel

All operations described in this operating instructions manual must be carried out by trained specialist personnel, authorised by the plant operator only.

Please make sure that you have read and understood these operating instructions and that you know all applicable legislations regarding occupational safety and accident prevention prior to installation and putting the component into operation.

The machine builder must carefully select the harmonised standards to be complied with as well as other technical specifications for the selection, mounting and integration of the components.

1.3 Explanation of the symbols used



Information, hint, note:

This symbol is used for identifying useful additional information.



Caution: Failure to comply with this warning notice could lead to failures or malfunctions.

Warning: Failure to comply with this warning notice could lead to physical injury and/or damage to the machine.

1.4 Appropriate use

The Schmersal range of products is not intended for private consumers.

The products described in these operating instructions are developed to execute safety-related functions as part of an entire plant or machine. It is the responsibility of the manufacturer of a machine or plant to ensure the correct functionality of the entire machine or plant.

The safety-monitoring module must be exclusively used in accordance with the versions listed below or for the applications authorised by the manufacturer. Detailed information regarding the range of applications can be found in the chapter "Product description".

1.5 General safety instructions

The user must observe the safety instructions in this operating instructions manual, the country specific installation standards as well as all prevailing safety regulations and accident prevention rules.



Further technical information can be found in the Schmersal catalogues or in the online catalogue on the Internet: products.schmersal.com.

The information contained in this operating instructions manual is provided without liability and is subject to technical modifications.

There are no residual risks, provided that the safety instructions as well as the instructions regarding mounting, commissioning, operation and maintenance are observed.

1.6 Warning about misuse



In case of inadequate or improper use or manipulations of the safety-monitoring module, personal hazards or damage to machinery or plant components cannot be excluded.

1.7 Exclusion of liability

We shall accept no liability for damages and malfunctions resulting from defective mounting or failure to comply with this operating instructions manual. The manufacturer shall accept no liability for damages resulting from the use of unauthorised spare parts or accessories.

For safety reasons, invasive work on the device as well as arbitrary repairs, conversions and modifications to the device are strictly forbidden; the manufacturer shall accept no liability for damages resulting from such invasive work, arbitrary repairs, conversions and/or modifications to the device.

The safety-monitoring module must only be used when the enclosure is closed, i.e. with the front cover fitted.

2. Product description

2.1 Ordering code

This operating instructions manual applies to the following types:

SRB324ST V.3



Only if the information described in this operating instructions manual are realised correctly, the safety function and therefore the compliance with the Machinery Directive is maintained.

2.2 Special versions

For special versions, which are not listed in the order code below 2.1, these specifications apply accordingly, provided that they correspond to the standard version.

2.3 Purpose

The safety-monitoring modules for integration in safety circuits are designed for fitting in control cabinets. They are used for the safe evaluation of the signals of positive break position switches for safety functions or magnetic safety sensors on sliding, hinged and removable safety guards as well as emergency stop control devices and AOPDs (safety light barriers).

The safety function is defined as the opening of the enabling circuits 13-14, 23-24 and 33-34 and the delayed opening of the enabling circuits 47-48 and 57-58 when the inputs S11-S12 and/or S21-S22 are opened. The safety-relevant current paths with the outputs contacts 13-14, 23-24 and 33-34 meet the following requirements under observation of a PFH value assessment (also refer to chapter 2.5 "Safety classification"):

- category 4 – PL e to EN ISO 13849-1
- corresponds to SIL 3 to EN 61508

The safety-relevant current paths with the outputs contacts 47-48 and 57-58 meet the following requirements under observation of a PFH value assessment (also refer to chapter 2.5 "Safety classification"):

- category 3 - PL d to EN ISO 13849-1
- corresponds to SIL 2 to EN 61508

To determine the Performance Level (PL) to EN ISO 13849-1 of the entire safety function (e.g. sensor, logic, actuator), an assessment of all relevant components is required.



The entire concept of the control system, in which the safety component is integrated, must be validated to the relevant standards.

2.4 Technical data

General data:

Standards:	EN 60204-1, EN 60947-5-1, EN ISO 13849-1, EN 61508
Climate resistance:	EN 60068-2-78
Mounting:	snaps onto standard rail to EN 60715
Terminal designations:	EN 60947-1
Material of the housings:	Plastic, glass-fibre reinforced thermoplastic, ventilated
Material of the contacts:	AgSnO, AgNi, self-cleaning, positive drive
Weight:	420 g
Start conditions:	Automatic or start button (monitored)
Feedback circuit available:	yes
Pull-in delay for automatic start:	typ. 250 ms
Pull-in delay with reset button:	typ. 20 ms
Drop-out delay in case of emergency stop:	typ. 30 ms / max. 36 ms
Drop-out delay on "supply failure":	typ. 80 ms

Mechanical data:

Connection type:	Screw connection
Cable sections:	0.25 ... 2.5 mm ²
Connecting cable:	rigid or flexible
Tightening torque for the terminals:	0.6 Nm
With removable terminals:	yes
Mechanical life:	10 million operations
Resistance to shock:	30 g / 11 ms
Resistance to vibration:	10 ... 150 Hz, Amplitude 0.35 mm
Ambient temperature:	–25 °C ... +60 °C
Storage and transport temperature:	–40 °C ... +85 °C
Protection class:	Enclosure: IP40 Terminals: IP20 Clearance: IP54
Air clearances and creepage distances to EN 60664-1:	4 kV/2 (basic insulation)
EMC rating:	to EMC Directive

Electrical data:

Contact resistance in new state:	max. 100 mΩ
Power consumption:	max. 3.2 W / 7.1 VA, plus signalling outputs
Rated operating voltage U _e :	24 VDC: –15% / +20%, residual ripple max. 10%, 24 VAC: –15% / +10%
Frequency range:	50 / 60 Hz
Fuse rating for the operating voltage:	Internal electronic trip, tripping current F1: > 2.5 A, tripping current F2: > 50 mA (S11-S31) / > 800 mA (X4)
Current and voltage at the control circuits:	
- S11, S12, S21, S22, S31, S32:	24 VDC, 10 mA
- X1, X2:	24 VDC, start impulse, 350 mA / 15 ms
- X3, X4:	24 VDC, start impulse, 130 mA / 80 ms
- X4, X5:	24 VDC, start impulse 140 mA / 15 ms

Monitored inputs:

Cross-wire detection:	optional
Wire breakage detection:	yes
Earth connection detection:	yes
Number of NO contacts:	0
Number of NC contacts:	2
Cable length:	850 m with 1.5 mm ² 1,400 m with 2.5 mm ²
Conduction resistance:	max. 40 Ω

Outputs:

Number of safety contacts:	5
Number of auxiliary contacts:	1
Number of signalling outputs:	3
Switching capacity of the safety contacts:	
- 13-14, 23-24, 33-34 (STOP 0):	max. 250 V, 8 A ohmic (inductive in case of appropriate protective wiring), AC-15: 230 VAC / 6 A, DC-13: 24 VDC / 6 A, Residual current at ambient temperature up to 45°C: 18 A / 55°C: 15 A / 60°C: 12 A
- 47-48, 57-58 (STOP 1):	max. 250 V, 6 A ohmic (inductive in case of appropriate protective wiring), AC-15: 230 VAC / 3 A, DC-13: 24 VDC / 2 A, Residual current at ambient temperature up to 45°C: 12 A / 55°C: 10 A / 60°C: 8 A

Switching capacity of the signalling outputs:	Y1-Y3: 24 VDC / 100 mA, residual current: 200 mA
Switching capacity of the auxiliary contacts:	61-62: 24 VDC / 2 A
Fuse rating of the safety contacts:	
- 13-14, 23-24, 33-34 (STOP 0):	external (I _k = 1000 A) to EN 60947-5-1 Safety fuse 10 A quick blow, 8 A slow blow,
- 47-48, 57-58 (STOP 1):	external (I _k = 1000 A) to EN 60947-5-1 Safety fuse 8 A quick blow, 6.3 A slow blow
Fuse rating for the auxiliary contacts:	external (I _k = 1000 A) to EN 60947-5-1 Safety fuse 2.5 A quick blow, 2 A slow blow
Utilisation category to EN 60947-5-1:	AC-15: 230 V / 3 A DC-13: 24 V / 2 A

The data specified in this manual are applicable when the component is operated with rated operating voltage U_e ±0%.

- Ⓢ Use copper conductors only.
- Use 60°C/75°C conductors
- Use No. 28-12 AWG wire size only
- Tightening torque: 5 lb in.
- Use 60/75°C wire only

2.5 Classification

Standards:	EN ISO 13849-1, EN 61508
PL:	STOP 0: up to e, STOP 1: up to d
Category:	STOP 0: up to 4, STOP 1: up to 3
PFH:	STOP 0: ≤ 2.0 × 10 ⁻⁸ /h, STOP 1: ≤ 2.0 × 10 ⁻⁷ /h
DC:	STOP 0: 99% (high), STOP 1: > 60% (low)
CCF:	> 65 points
SIL:	STOP 0: suitable for SIL 3 applications STOP 1: suitable for SIL 2 applications
Mission time:	20 years
B _{10D} value (for one channel of the relay output):	20%: 20,000,000 40%: 7,500,000 60%: 2,500,000 80%: 1,000,000 100%: 400,000

$$MTTF_D = \frac{B_{10D}}{0,1 \times n_{op}} \quad n_{op} = \frac{d_{op} \times h_{op} \times 3600 \text{ s/h}}{t_{cycle}}$$

For an average annual demand rate of n_{op} = 126,720 cycles per year, Performance Level PL e can be obtained at maximum load.

- n_{op} = average number of activations per year
- d_{op} = average number of operating days per year
- h_{op} = average number of operating hours per day
- t_{cycle} = average demand rate of the safety function in s (e.g. 4 × per hour = 1 × per 15 min. = 900 s)

(Determined values can vary depending on the application-specific parameters h_{op}, d_{op} and t_{cycle} as well as the load.)

The PFH values of 2.0 × 10⁻⁸/h and 2.0 × 10⁻⁷/h applies to the combinations of contact load (current through enabling contacts) and number of switching cycles (n_{op/ly}) mentioned in the table below. At 365 operating days per year and a 24-hours operation, this results in the below-mentioned switching cycle times (t_{cycle}) for the relay contacts. Diverging applications upon request.

Contact load	n _{op/ly}	t _{cycle}
20 %	525,600	1.0 min
40 %	210,240	2.5 min
60 %	75,087	7.0 min
80 %	30,918	17.0 min
100 %	12,223	43.0 min

3. Mounting

3.1 General mounting instructions

Mounting: snaps onto standard rails to EN 60715.

Snap the bottom of the enclosure slightly tilted forwards in the rail and push up until it latches in position.



To avoid EMC disturbances, the physical ambient and operational conditions at the place where the product is installed, must meet the provisions laid down in the paragraph "Electromagnetic Compatibility (EMC)" of EN 60204-1.

3.2 Dimensions

Device dimensions (H/W/D): 100 x 45 x 121 mm
with plugged-in terminals: 120 × 45 × 121 mm

4. Electrical connection

4.1 General information for electrical connection



As far as the electrical safety is concerned, the protection against unintentional contact of the connected and therefore electrically interconnected apparatus and the insulation of the feed cables must be designed for the highest voltage, which can occur in the device.



The electrical connection may only be carried out by authorised personnel in a de-energised condition.

Settle length x of the conductor: 7 mm



Wiring examples: see appendix

5. Operating principle and settings

5.1 LED functions

- K1: Status channel 1
- K2: Status channel 2
- K3/K4: Status delayed enabling circuit (LED is ON, when the delayed enabling circuits 47-48, 57-58 are closed)
- U_B: Status operating voltage (LED is on, when the operating voltage on the terminals A1-A2 is ON)
- U_i: Status internal operating voltage (LED is on, when the operating voltage on the terminals A1-A2 is ON and the fuse has not been triggered).

5.2 Description of the terminals (see Fig. 1)

Voltages:	A1	+24 VDC / 24 VAC
	A1.1	+24 VDC / 24 VAC
	A2	0 VDC / 24 VAC
Inputs:	S11-S12	Input channel 1 (+)
	S21-S22	Input channel 2 (-) (with cross-wire short detection)
	S31-S32	Input channel 2 (+) (without cross-wire short detection)
Outputs:	13-14	First safety enabling circuit (STOP 0)
	23-24	Second safety enabling circuit (STOP 0)
	33-34	Third safety enabling circuit (STOP 0)
	47-48	Fourth safety enabling circuit (STOP 1)
	57-58	Fifth safety enabling circuit (STOP 1)
	61-62	Auxiliary NC contact
Start:	X1-X2	Feedback circuit
	X3-X4	Feedback circuit and external reset (monitored)
	X4-X5	Automatic start
	Y1 + Y2	Signalling output channel 1 and 2
	Y3	Fuse F3
	RT	Reset timer

 Signalling outputs must not be used in safety circuits.

Opening the front cover (see Fig. 2)

- To open the front cover, insert a slotted screwdriver in the top and bottom cover notch and gently lift it.
- When the front cover is open, the electrostatic discharge requirements must be respected and observed.
- After setting, the front cover must be fitted back in position.
- The set drop-out delay must be entered on the front cover.

 Only touch the components after electrical discharge!

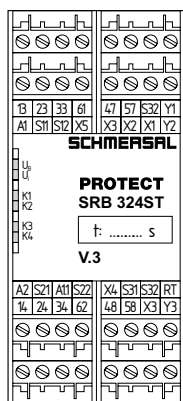

Fig. 1

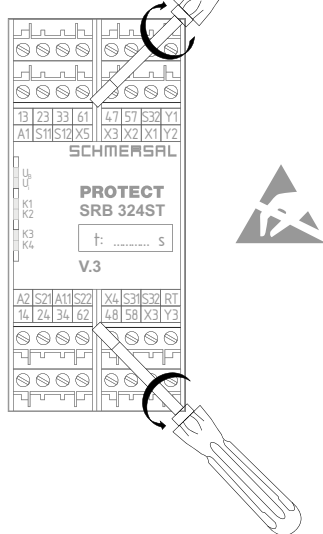

Fig. 2

Time setting (see Fig. 3 and 4)



DIP switch settings:

- The DIP switches are located underneath the front cover of the safety-monitoring module (see Fig. 3 and 4).
- Both DIP switches SW 1 (channel 1) and SW 2 (channel 2) must be set identically.
- The DIP switches can be set when the operating voltage is on; however, in order for the setting to be saved in the SRB, the voltage supply must be interrupted for approx. 3 seconds.
- The functionality of the setting must be checked.

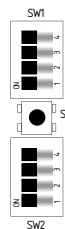

Fig. 3

















DIP switch setting	Drop-out delay	DIP switch setting	Drop-out delay
	< 0,1 s		5.0 s
	0.5 s		8.5 s
	1.0 s		10.0 s
	1.5 s		12.0 s
	2.0 s		15.0 s
	2.5 s		20.0 s
	3.0 s		25.0 s
	4.0 s		30.0 s

Fig. 4 (Tolerance $\pm 2\%$)

Resetting the hybrid fuse

- The hybrid fuse of the safety-monitoring module can be reset by switching the operating voltage off and back on or by actuating button S1.
- Button S1 is located underneath the front cover of the safety-monitoring module (see Fig. 2 and 3).

5.3 Notes

Reduction of the delay time (see Fig. 5)

- The drop-out delay time can be terminated prematurely via the input RT.
- The drop-out delay can be prematurely terminated by supplying terminal RT with +24 V (rising edge).
- The +24V is made available either at the terminals S11, S31, X4 or A1.1.

Delayed enabling circuits (see Fig. 6)

- The drop-out delay of the safety enabling circuits 47-48 and 57-58 can be set within the range of 0...30 seconds by means of DIP switches. The DIP switches are located underneath the front cover of the safety-monitoring module.
- The safety enabling circuits 47-48 and 57-58 meet STOP category 1 to EN 60204-1.
- The safety enabling circuits 13-14, 23-24 and 33-34 meet STOP category 0 to EN 60204-1.

Signalling outputs (see Fig. 7)

- The input circuits are signalled through the signalling outputs Y1 (channel 1) and Y2 (channel 2).
- The hybrid fuse of the safety-monitoring module can be reset by switching the operating voltage off and back on or by actuating button S1.
- Button S1 is located underneath the front cover of the safety-monitoring module.
- The status of the hybrid fuse is signalled through signalling output Y3. If the hybrid fuse is not activated, Y3 is supplied with operating voltage.



Fig. 5

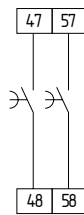

Fig. 6

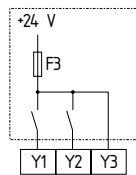

Fig. 7

5.4 Setting report SRB324ST V.3

This report regarding the setting of the device must be completed accordingly by the customer, enclosed in the technical manual of the machine and indicated on the front cover.

The setting report must be available whenever a safety check is performed.

Company: _____

The safety-monitoring module is used in the following machine:

Machine n° _____ Machine type _____ Module n° _____

Set drop-out delay: _____

Set on (date) _____ Signature of the responsible person _____

6. Set-up and maintenance

6.1 Functional testing

The safety function of the safety-monitoring module must be tested. The following conditions must be previously checked and met:

1. Correct fixing
2. Check the integrity of the cable entry and connections
3. Check the safety-monitoring module's enclosure for damage.
4. Check the electrical function of the connected sensors and their influence on the safety-monitoring module and the downstream actuators

6.2 Maintenance

A regular visual inspection and functional test, including the following steps, is recommended:

1. Check the correct fixing of the safety-monitoring module
2. Check the cable for damages
3. Check electrical function
4. Check drop-out delay



The device has to be integrated into the periodic check-ups according to the Ordinance on Industrial Safety and Health, however at least 1 × year.

Damaged or defective components must be replaced.

7. Disassembly and disposal

7.1 Disassembly

The safety-monitoring module must be disassembled in a de-energised condition only.

Push up the bottom of the enclosure and hang out slightly tilted forwards.

7.2 Disposal

The safety-monitoring module must be disposed of in an appropriate manner in accordance with the national prescriptions and legislations.

8. Appendix

8.1 Wiring examples

Dual-channel control, shown for a guard door monitor; with two contacts A and B, where at least one is a positive break contact; with external reset button (R)

- Relay outputs: Suitable for 2-channel control, for increase in capacity or number of contacts by means of contactors or relays with positive-guided contacts.
- The control system recognises wire breakage, earth faults and cross-wire shorts in the monitoring circuit.
- **F2** = hybrid fuse 50 mA / 800 mA
- (R) = feedback circuit

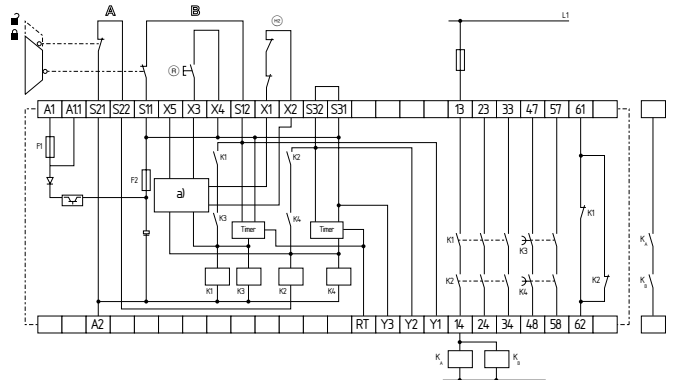

Fig. 8 a) channel control

8.2 Start configuration

External reset button (with edge detection) (see Fig. 9)

- The external reset button is integrated as shown.
- The safety-monitoring module is activated by the reset (after release) of the reset button (= detection of the trailing edge). Faults in the reset button, e.g. welded contacts or manipulations which could lead to an inadvertent restart, are detected in this configuration and will result in an inhibition of the operation.
- An output with 24 V / 250 mA must be made available by the control system. This output must be connected to X3. X3 must be switched on for at least 100 ms (HIGH). The safety-monitoring module is activated by switching the output off (LOW).

Automatic start (see Fig. 10)

- The automatic start is programmed by connecting the feedback circuit to the terminals. If the feedback circuit is not required, establish a bridge.



Not admitted without additional measure due to the risk of gaining access by stepping behind!



Caution: When the 324ST V.3 safety-monitoring module is used with the operating mode "Automatic start", an automatic restart after a shutdown in case of emergency must be prevented by the upstream control to EN 60204-1 paragraph 9.2.3.4.2.

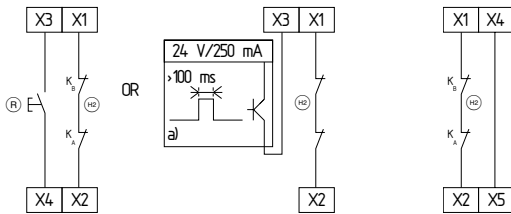

Fig. 9 a) Controller

Fig. 10

8.3 Sensor configuration

Dual-channel control of a safety-related electronic (microprocessor-based) safety guard with p-type transistor outputs e.g. AOPDs to IEC 61496 (see Fig. 11)

- Wire breakage and earth leakage in the control circuits are detected.
- The safety-monitoring module therefore is not equipped with a cross-wire short detection here. The safety-monitoring module therefore is not equipped with a cross-wire short detection here.
- If cross-wire shorts in the control circuits are detected by the safety guard: category 4 – PL e to EN ISO 13849-1 possible.

Single-channel emergency stop circuit with command devices to EN ISO 13850 and IEC 60947-5-5 (see Fig. 12)

- Wire breakage and earth leakage in the control circuits are detected.
- Category 1 – PL c to EN ISO 13849-1 possible.

Dual-channel emergency stop circuit with command devices to EN ISO 13850 and EN 60947-5-5 (see Fig. 13)

- Wire breakage and earth leakage in the control circuits are detected.
- Cross-wire shorts between the control circuits are not detected.
- Category 4 – PL e to EN ISO 13849-1 possible (with protective wiring)

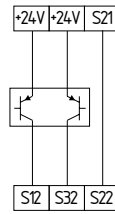

Fig. 11

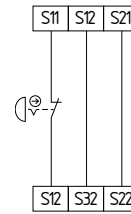

Fig. 12

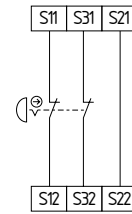

Fig. 13

Dual-channel emergency stop circuit with command devices to EN ISO 13850 and EN 60947-5-5 (see Fig. 14)

- Wire breakage and earth leakage in the control circuits are detected.
- Cross-wire shorts between the control circuits are detected.
- Category 4 – PL e to EN ISO 13849-1 possible.

Single-channel guard door monitoring circuit with interlocking devices to EN ISO 14119 (see Fig. 15)

- At least one contact with positive break required.
- Wire breakage and earth leakage in the control circuits are detected.
- Category 1 – PL c to EN ISO 13849-1 possible.

Dual-channel guard door monitoring circuit with interlocking device to EN ISO 14119 (see Fig. 16)

- At least one contact with positive break required.
- Wire breakage and earth leakage in the control circuits are detected.
- Cross-wire shorts between the monitoring circuits are not detected.
- Category 4 – PL e to EN ISO 13849-1 possible (with protective wiring)

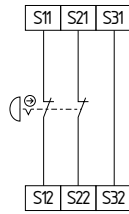

Fig. 14

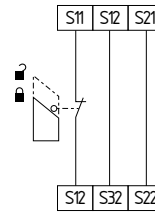

Fig. 15

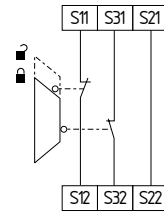

Fig. 16

Dual-channel guard door monitoring circuit with interlocking device to EN ISO 14119 (see Fig. 17)

- At least one contact with positive break required.
- Wire breakage and earth leakage in the control circuits are detected.
- Cross-wire shorts between the guard monitoring circuits are detected.
- Category 4 – PL e to EN ISO 13849-1 possible.

Dual-channel control of magnetic safety switches according to EN 60947-5-3 (see Fig. 18)

- Wire breakage and earth leakage in the control circuits are detected.
- Cross-wire shorts between the control circuits are not detected.
- Category 3 – PL e to EN ISO 13849-1 possible.

Dual-channel control of magnetic safety switches according to EN 60947-5-3 (see Fig. 19)

- Wire breakage and earth leakage in the control circuits are detected.
- Cross-wire shorts between the control circuits are detected.
- Category 4 – PL e to EN ISO 13849-1 possible.

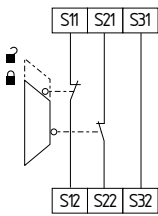

Fig. 17

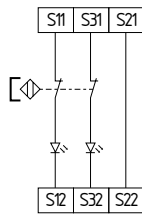

Fig. 18

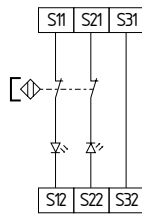

Fig. 19



The connection of magnetic safety switches to the SRB324ST V.3 safety-monitoring module is only admitted when the requirements of the standard EN 60947-5-3 are observed.

As the technical data are regarded, the following minimum requirements must be met:

- switching capacity: min. 240 mW
- switching voltage: min. 24 VDC
- switching current: min. 10 mA



For example, the following safety sensors meet the requirements:

- BNS 33-02Z-2187, BNS 33-02ZG-2187
- BNS 260-02Z, BNS 260-02ZG
- BNS 260-02/01Z, BNS 260-02/01ZG



When sensors with LED are wired in the control circuit (protective circuit), the following rated operating voltage must be observed and respected:

- 24 VDC with a max. tolerance of -5%/+20 %
- 24 VAC with a max. tolerance of -5%/+10 %

Otherwise availability problems could occur, especially in series-wired sensors, where a voltage drop in the control circuit is triggered by LEDs for instance.

8.4 Actuator configuration

Single-channel control with feedback circuit (see Fig. 20)

- Suitable for increase in capacity or number of contacts by means of contactors or relays with positive-guided contacts.
- \oplus = feedback circuit:
If the feedback circuit is not required, establish a bridge.

Dual-channel control with feedback circuit (see Fig. 21)

- Suitable for increase in capacity or number of contacts by means of contactors or relays with positive-guided contacts.
- \oplus = feedback circuit:
If the feedback circuit is not required, establish a bridge.

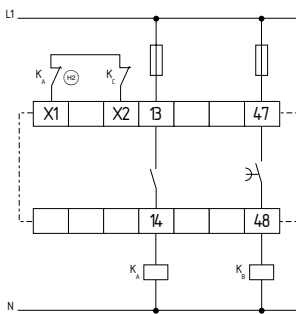

Fig. 20

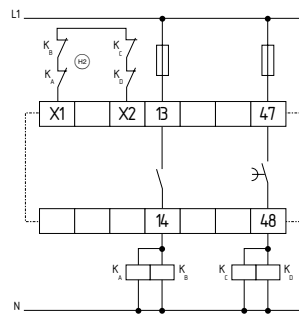

Fig. 21

Differential control with feedback circuit (see Fig. 22)

- Suitable for increase in capacity or number of contacts by means of contactors or relays with positive-guided contacts.
- \oplus = feedback circuit:
If the feedback circuit is not required, establish a bridge. If the enabling circuit of the controller must be equipped with its own feedback circuit, this circuit must be integrated as shown in the wiring example "dual-channel control with feedback circuit" (see there).

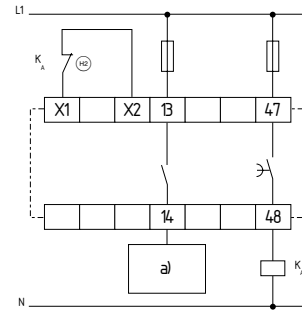

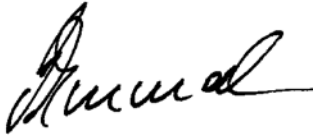

Fig. 22 a) Enabling signal controller

9. EU Declaration of conformity

EU Declaration of conformity		 SCHMERSAL
Original	K.A. Schmersal GmbH & Co. KG Möddinghofe 30 42279 Wuppertal Germany Internet: www.schmersal.com	
We hereby certify that the hereafter described components both in their basic design and construction conform to the applicable European Directives.		
Name of the component:	SRB324ST V.3	
Description of the component:	Safety-monitoring module for emergency stop circuits, guard door monitoring, magnetic safety switches and AOPDs	
Relevant Directives:	Machinery Directive EMC-Directive RoHS-Directive	2006/42/EC 2014/30/EU 2011/65/EU
Applied standards:	EN ISO 13850:2015 EN ISO 13849-1:2015 EN ISO 13849-2:2012 EN 60947-5-3:2013 (in extracts)	
Notified body for the prototype test:	TÜV Rheinland Industrie Service GmbH Am Grauen Stein, 51105 Köln ID n°: 0035	
EC-prototype test certificate:	01/205/5222.02/22	
Person authorised for the compilation of the technical documentation:	Oliver Wacker Möddinghofe 30 42279 Wuppertal	
Place and date of issue:	Wuppertal, October 19, 2022	
SRB324ST-V3-F-DE		
	Authorised signature Philip Schmersal Managing Director	



The currently valid declaration of conformity can be downloaded from the internet at products.schmersal.com.

