



EN Operating instructions.pages 1 to 6
Original

Content

1 About this document

1.1 Function 1

1.2 Target group: authorised qualified personnel. 1

1.3 Explanation of the symbols used 1

1.4 Appropriate use 1

1.5 General safety instructions 1

1.6 Warning about misuse 1

1.7 Exclusion of liability 2

2 Product description

2.1 Ordering code 2

2.2 Special versions. 2

2.3 Purpose 2

2.4 Technical data 2

2.5 Safety classification 2

3 Mounting

3.1 General mounting instructions 3

3.2 Dimensions 3

3.3 Axial misalignment. 3

3.4 Adjustment. 4

4 Rear side Electrical connection

4.1 General information for electrical connection. 4

4.2 Contact variants. 4

5 Set-up and maintenance

5.1 Functional testing. 5

5.2 Maintenance 5

6 Disassembly and disposal

6.1 Disassembly. 5

6.2 Disposal 5

7 EU Declaration of conformity

1. About this document

1.1 Function

This operating instructions manual provides all the information you need for the mounting, set-up and commissioning to ensure the safe operation and disassembly of the safety switchgear. The operating instructions must be available in a legible condition and a complete version in the vicinity of the device.

1.2 Target group: authorised qualified personnel

All operations described in this operating instructions manual must be carried out by trained specialist personnel, authorised by the plant operator only.

Please make sure that you have read and understood these operating instructions and that you know all applicable legislations regarding occupational safety and accident prevention prior to installation and putting the component into operation.

The machine builder must carefully select the harmonised standards to be complied with as well as other technical specifications for the selection, mounting and integration of the components.

1.3 Explanation of the symbols used



Information, hint, note:
This symbol is used for identifying useful additional information.



Caution: Failure to comply with this warning notice could lead to failures or malfunctions.
Warning: Failure to comply with this warning notice could lead to physical injury and/or damage to the machine.

1.4 Appropriate use

The products described in these operating instructions are developed to execute safety-related functions as part of an entire plant or machine. It is the responsibility of the manufacturer of a machine or plant to ensure the correct functionality of the entire machine or plant.

The safety switchgear must be exclusively used in accordance with the versions listed below or for the applications authorised by the manufacturer. Detailed information regarding the range of applications can be found in the chapter "Product description".

1.5 General safety instructions

The user must observe the safety instructions in this operating instructions manual, the country specific installation standards as well as all prevailing safety regulations and accident prevention rules.



Further technical information can be found in the Schmersal catalogues or in the online catalogue on the Internet: www.schmersal.net.

The information contained in this operating instructions manual is provided without liability and is subject to technical modifications.

There are no residual risks, provided that the safety instructions as well as the instructions regarding mounting, commissioning, operation and maintenance are observed.

1.6 Warning about misuse



In case of improper use or manipulation of the safety switchgear, personal hazards or damages to machinery or plant components cannot be excluded. The relevant requirements of the standard ISO 14119 must be observed.

1.7 Exclusion of liability

We shall accept no liability for damages and malfunctions resulting from defective mounting or failure to comply with this operating instructions manual. The manufacturer shall accept no liability for damages resulting from the use of unauthorised spare parts or accessories.

For safety reasons, invasive work on the device as well as arbitrary repairs, conversions and modifications to the device are strictly forbidden; the manufacturer shall accept no liability for damages resulting from such invasive work, arbitrary repairs, conversions and/or modifications to the device.

2. Product description

2.1 Ordering code

This operating instructions manual applies to the following types:

BNS 303-①Z②③-④⑤

No.	Option	Description
①	02	2 NC contacts
	11	1 NO contacts / 1 NC contacts
	12	1 NO contact / 2 NC contact
②	G	without LED
	G	with LED
③		connecting cable
	ST	M12 x 1 connector
④	2211	increased switching distance
⑤	/2717	Connecting cable (3 m) with connector HAN Q5

2.2 Special versions

For special versions, which are not listed in the order code below 2.1, these specifications apply accordingly, provided that they correspond to the standard version.

2.3 Purpose

The safety sensor is designed for application in safety circuits and is used for monitoring the position of movable safety guards to ISO 14119 and IEC 60947-5-3. To actuate the safety sensors, only the BPS 300, BPS 303 or BPS 303 SS actuators can be used, conventional magnets are not suitable.

The safety sensors are used for applications, in which the hazardous situation is terminated without delay when the safety guard is opened.



The safety switchgears are classified according to ISO 14119 as type 4 switching devices.

Only the entire system consisting of the safety sensor (BNS), the actuator (BPS) and the safety-monitoring module (AES/SRB/AZR) meets the requirements of the standard IEC 60947-5-3.



The user must evaluate and design the safety chain in accordance with the relevant standards and the required safety level.



The entire concept of the control system, in which the safety component is integrated, must be validated to the relevant standards.

2.4 Technical data

Standards:	IEC 60947-5-3, BG-GS-ET-14
Enclosure:	glass-fibre reinforced thermoplastic
Tightening torque:	for SW 36 nuts max. 300 Ncm
Protection class:	IP67 to IEC 60529
Termination:	Boflex cable or M12 connector
Connecting cable:	4 x 0.25 mm ²
Version with integrated connector:	M12 x 1, 4-pole
Connecting cable with Harting-connector:	4 x 0.25 mm ² ; HAN Q5, 6-pole
Operating principle:	magnetic
Actuator:	BPS 300, BPS 303, BPS 303 SS, coded
Coding level according to ISO 14119:	low
Switching distances:	
- Assured switching distance s_{ao} :	5 mm, 8 mm (ordering suffix -2211)
- Assured switch-off distance s_{ar} :	15 mm, 18 mm (ordering suffix -2211)
Switching condition indication:	LED only with ordering suffix G
Rated insulation voltage U_i :	125 V
Rated impulse withstand voltage U_{imp} :	0.8 kV
Switching voltage:	without LED: max. 100 VAC/DC with LED: max. 24 VDC
Switching current:	without LED: max. 400 mA with LED: max. 10 mA
Switching capacity:	without LED: max. 10 W with LED: max. 240 mW
Required short-circuit current:	100 A
Ambient temperature:	-25 °C ... +70 °C
Storage and transport temperature:	-25 °C ... +70 °C
Max. switching frequency:	5 Hz
Resistance to shock:	30 g / 11 ms
Resistance to vibration:	10 ... 55 Hz, amplitude 1 mm



Same Polarity.

For use in NFPA 79 Applications.

Adapters providing field wiring means are available from the manufacturer.

Refer to manufacturers information.

2.5 Safety classification

Standards:	ISO 13849-1
Safety contacts:	
- NC / NC combination:	S21-S22 and S11-S12
- NC / NO combination:	S21-S22 and S13-S14 or C-S22 and C-S14
Intended structure:	
- 2-channel usage:	usable to cat. 4 / PL e with suitable logic unit
B_{10D} NC contacts at 20 % contact load:	25.000.000
B_{10D} NO contacts at 20 % contact load:	25.000.000
Service life:	20 years

$$MTTF_D = \frac{B_{10D}}{0,1 \times n_{op}} \quad n_{op} = \frac{d_{op} \times h_{op} \times 3600 \text{ s/h}}{t_{cycle}}$$

(Determined values can vary depending on the application-specific parameters h_{op} , d_{op} and t_{cycle} as well as the load.)

An individual switch can be used in a category 3 or 4 architecture up to PL e.

If multiple safety components are wired in series, the Performance Level to ISO 13849-1 will be reduced due to the restricted error detection under certain circumstances.

3. Mounting

3.1 General mounting instructions



During fitting, the requirements of ISO 14119 must be observed.

- Fitting is only authorised in a de-energised condition
- Do not use the sensor and the actuator as a mechanical backstop
- Any mounting position, provided that the active surfaces are opposite
- The safety sensor must be fixed by means of both nuts in the provided mounting hole (max. tightening torque 300 Ncm).
- Do not install the safety sensor and the actuator in strong magnetic fields
- If possible, do not mount the sensor and the actuator on ferromagnetic material. When the sensor and the actuator are installed on ferromagnetic material, variations can be expected in the limit distances.
- Do not subject the safety sensor and actuator to extreme vibrations and shocks.
- Keep away from metal chips
- The mounting distance between two sensors should always be at least 50 mm.



Safety sensor and actuator must be permanently fitted to the safety guards and protected against displacement by suitable measures (tamperproof screws, gluing, drilling of the screw heads).

3.2 Dimensions

All measurements in mm.

Safety sensor BNS 303

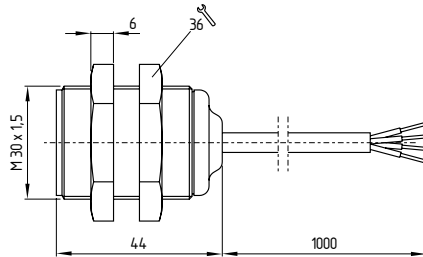

Safety sensor BNS 303 ST

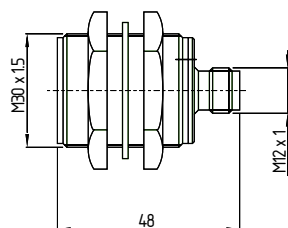

Actuator BPS 300 with plastic enclosure

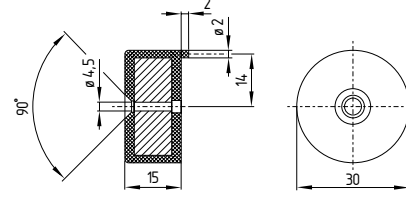

Actuator BPS 303 for food-processing industry, with plastic enclosure

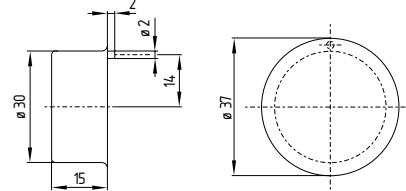

Actuator BPS 303 SS for food-processing industry, with metal enclosure

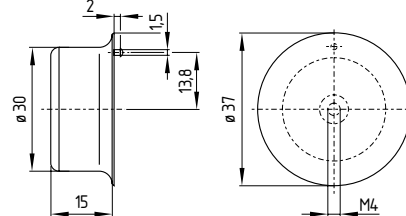

Actuator BPS 303 and BPS 303 SS

The actuators are primarily provided for use in the food-processing industry and therefore are not labelled. The actuators are fixed by means of the supplied tamper-proof screws. The mounting hole must have a diameter of 4.5 mm. Next to the mounting hole, a second mounting hole must be provided. This hole is used for the fixture of the displacement protection dowel. Position of the dowel: refer to the image in chapter "Axial misalignment".

3.3 Axial misalignment

A horizontal and vertical misalignment of the safety sensor and the actuator is tolerated. The possible misalignment depends on the distance of the active surfaces of the sensor and the actuator. The sensor remains active within the tolerance range.

The specified switching distances refer to oppositely mounted safety sensors and actuators.

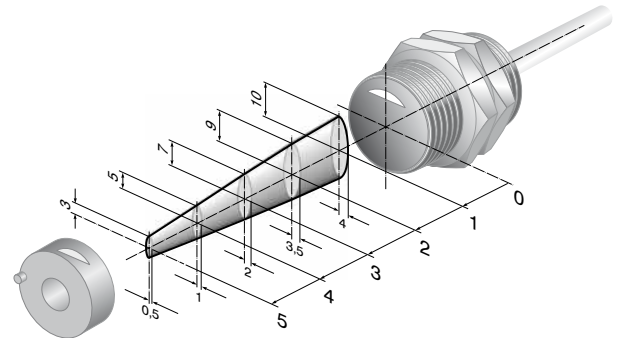

assured switching distance: $s_{ao} = 5 \text{ mm}$
8 mm (Ordering suffix -2211)
assured switch-off distance: $s_{ar} = 15 \text{ mm}$
18 mm (Ordering suffix -2211)

3.4 Adjustment

The LED can only be used as rough setting tool. The correct functionality of both safety channels must be checked by means of the connected safety-monitoring module.



Recommended Adjustment

Align the safety sensor and actuator at a distance of $0.5 \times s_{a0}$.

4. Rear side Electrical connection

4.1 General information for electrical connection



The electrical connection may only be carried out by authorised personnel in a de-energised condition.

The safety sensors must be wired in accordance with the wire colours or the pin configuration.

4.2 Contact variants

The contact position shows the actuated sensor function when the safety guard is closed.

Safety contacts: S21-S22 and S11-S12 or S13-S14
or C-S22 and C-S14
Signalling contact: S31-S32 or C-S32

BNS 303-02Z
BNS 303-02Z-2211
BK 11 — 12 BU
WH 21 — 22 BN

BNS 303-02ZG
BNS 303-02ZG-2211
BK 11 — 12 BU
WH 21 — 22 BN

BNS 303-11Z
BNS 303-11Z-2211
BK 13 — 14 BU
WH 21 — 22 BN

BNS 303-11ZG
BNS 303-11ZG-2211
BK 13 — 14 BU
WH 21 — 22 BN

BNS 303-12Z
BNS 303-12Z-2211
BK 22 — 14 BU
WH 32 — C BN

BNS 303-12ZG
BNS 303-12ZG-2211
BK 22 — 14 BU
WH 32 — C BN

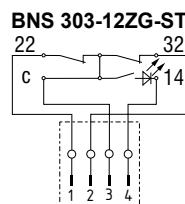
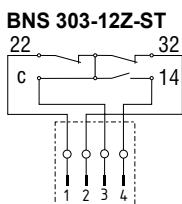
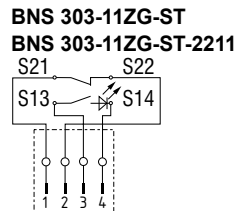
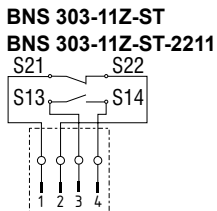
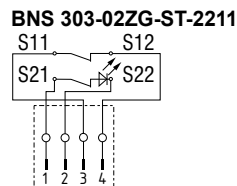
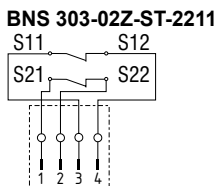

Information for the selection of suitable safety-monitoring modules can be found in the Schmersal catalogues or in the online catalogue on our website: www.schmersal.net.

Technically, multiple safety sensors can be wired to one AES safety-monitoring module (check if authorised!). The NO contacts are wired parallel and the NC contacts in series. The PROTECT-IE-11 or -02 or PROTECT-PE-11 (-AN) or -02 input expander module can be used to connect up to 4 safety sensors with NC/NO or NC/NC contacts.

Safety sensors equipped with LED's shall not be wired in series, except for the PROTECT-IE or PROTECT-PE input expander module. As a result of this, the luminosity of the LED's would considerably decrease and the voltage could drop below the minimum input voltage of the downstream safety-monitoring module.

Connector plug

integrated connector

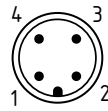

M12, 4-pole

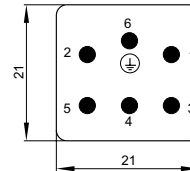

HAN Q5, 6-pole

Accessories: connecting cable with M 12 coupling, 4 pole
(Ordering code: 101208523)

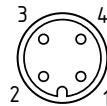

1 BN
2 WH
3 BU
4 BK

5. Set-up and maintenance

5.1 Functional testing

The safety function of the safety components must be tested. The following conditions must be previously checked and met:

1. Fitting of the sensor and the actuator.
2. Fitting and integrity of the power cable.
3. The system is free of dirt and soiling (in particular metal chips).

5.2 Maintenance

In the case of correct installation and adequate use, the safety sensor features maintenance-free functionality.

A regular visual inspection and functional test, including the following steps, is recommended:

- Check the fitting of the sensor and the actuator.
- Remove possible metal chips.
- Check the cable for damage.



Adequate measures must be taken to ensure protection against tampering either to prevent tampering of the safety guard, for instance by means of replacement actuators.

Damaged or defective components must be replaced.

6. Disassembly and disposal

6.1 Disassembly

The safety switchgear must be disassembled in a de-energised condition only.

6.2 Disposal

The safety switchgear must be disposed of in an appropriate manner in accordance with the national prescriptions and legislations.

7. EU Declaration of conformity

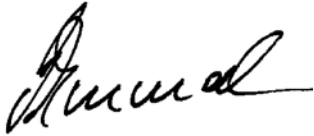
EU Declaration of conformity		
Original	K.A. Schmersal GmbH & Co. KG Möddinghofe 30 42279 Wuppertal Germany Internet: www.schmersal.com	
We hereby certify that the hereafter described components both in their basic design and construction conform to the applicable European Directives.		
Name of the component:	BNS 303	
Type:	See ordering code	
Description of the component:	Safety-sensor with magnetic operating principle in combination with the AES / AZR / SRB safety-monitoring modules from Schmersal or an equivalent safety-oriented control system fulfilling the requirements of the DIN EN 60947-5-3.	
Relevant Directives:	Machinery Directive RoHS-Directive	2006/42/EC 2011/65/EU
Applied standards:	DIN EN 60947-5-3: 2014, DIN EN ISO 14119: 2014	
Person authorised for the compilation of the technical documentation:	Oliver Wacker Möddinghofe 30 42279 Wuppertal	
Place and date of issue:	Wuppertal, March 2, 2016	
		
	Authorised signature Philip Schmersal Managing Director	

BNS303-H-EN



The currently valid declaration of conformity can be downloaded from the internet at www.schmersal.net.



K. A. Schmersal GmbH & Co. KG
Möddinghofe 30, D - 42279 Wuppertal
Postfach 24 02 63, D - 42232 Wuppertal

Phone: +49 - (0)2 02 - 64 74 - 0
Telefax: +49 - (0)2 02 - 64 74 - 1 00
E-Mail: info@schmersal.com
Internet: <http://www.schmersal.com>