



EN Operating instructions.pages 1 to 8
Original

Content

1 About this document

1.1 Function 1

1.2 Target group: authorised qualified personnel. 1

1.3 Explanation of the symbols used 1

1.4 Appropriate use 1

1.5 General safety instructions 1

1.6 Warning about misuse 2

1.7 Exclusion of liability 2

2 Product description

2.1 Ordering code 2

2.2 Special versions. 2

2.3 Purpose 2

2.4 Technical data 3

2.5 Safety classification of the interlocking function. 3

2.6 Safety classification of the guard locking function. 3

3 Mounting

3.1 General mounting instructions 4

3.2 Dimensions 4

4 Electrical connection

4.1 General information for electrical connection. 4

4.2 Contact variants. 5

5 Set-up and maintenance

5.1 Functional testing. 6

5.2 Maintenance 6

6 Disassembly and disposal

6.1 Disassembly. 6

6.2 Disposal 6

7 EU Declaration of conformity

1. About this document

1.1 Function

This operating instructions manual provides all the information you need for the mounting, set-up and commissioning to ensure the safe operation and disassembly of the safety switchgear. The operating instructions must be available in a legible condition and a complete version in the vicinity of the device.

1.2 Target group: authorised qualified personnel

All operations described in this operating instructions manual must be carried out by trained specialist personnel, authorised by the plant operator only.

Please make sure that you have read and understood these operating instructions and that you know all applicable legislations regarding occupational safety and accident prevention prior to installation and putting the component into operation.

The machine builder must carefully select the harmonised standards to be complied with as well as other technical specifications for the selection, mounting and integration of the components.

1.3 Explanation of the symbols used

 **Information, hint, note:**
This symbol is used for identifying useful additional information.

 **Caution:** Failure to comply with this warning notice could lead to failures or malfunctions.
Warning: Failure to comply with this warning notice could lead to physical injury and/or damage to the machine.

1.4 Appropriate use

Products in Schmersal's range are not intended to be used by private end consumers.

The products described in these operating instructions are developed to execute safety-related functions as part of an entire plant or machine. It is the responsibility of the manufacturer of a machine or plant to ensure the correct functionality of the entire machine or plant.

The safety switchgear must be exclusively used in accordance with the versions listed below or for the applications authorised by the manufacturer. Detailed information regarding the range of applications can be found in the chapter "Product description".

1.5 General safety instructions

The user must observe the safety instructions in this operating instructions manual, the country specific installation standards as well as all prevailing safety regulations and accident prevention rules.

 Further technical information can be found in the Schmersal catalogues or in the online catalogue on the Internet: products.schmersal.com.

The information contained in this operating instructions manual is provided without liability and is subject to technical modifications.

There are no residual risks, provided that the safety instructions as well as the instructions regarding mounting, commissioning, operation and maintenance are observed.

1.6 Warning about misuse



In case of improper use or manipulation of the safety switch-gear, personal hazards or damages to machinery or plant components cannot be excluded. The relevant requirements of the standard EN ISO 14119 must be observed.

1.7 Exclusion of liability

We shall accept no liability for damages and malfunctions resulting from defective mounting or failure to comply with this operating instructions manual. The manufacturer shall accept no liability for damages resulting from the use of unauthorised spare parts or accessories.

For safety reasons, invasive work on the device as well as arbitrary repairs, conversions and modifications to the device are strictly forbidden, the manufacturer shall accept no liability for damages resulting from such invasive work, arbitrary repairs, conversions and/or modifications to the device.

2. Product description

2.1 Ordering code

This operating instructions manual applies to the following types:

AZM190-①RK②③-④-⑤-⑥-⑦

No.	Option	Description	
①		Magnet: Actuator:	
	02/01	2 NC 1 NC	
	02/02	2 NC 2 NC	
	02/10	2 NC 1 NO	
	02/11	2 NC 1 NO / 1 NC	
	11/01	1 NO / 1 NC 1 NC	
	11/02	1 NO / 1 NC 2 NC	
	11/10	1 NO / 1 NC 1 NO	
	11/11	1 NO / 1 NC 1 NC / 1 NO	
	②	A	Power to unlock
			Power to lock
③		With manual release on the cover side	
	E0	Without manual release	
	E1	With manual release from side (right)	
	N	Emergency release	
	T	Emergency exit	
④		Without LED display	
	G	With LED display (only for 24 VAC/DC, not for -E1 and -T)	
⑤	MPV	With mounting plate MP190-V	
	MPVD	With mounting plate MP190-VD	
⑥	24VAC	U _s 24 VAC	
	24 VDC	U _s 24 VDC	
	48VAC	U _s 48 VAC	
	110VAC	U _s 110 VAC	
	230VAC	U _s 230 VAC	
⑦	3023-1	Actuating head rotated 90°	
	3023-2	Actuating head rotated 270°	

Not all component variants, which are possible according to this order code, are available.



Only if the information described in this operating instructions manual are realised correctly, the safety function and therefore the compliance with the Machinery Directive is maintained.

2.2 Special versions

For special versions, which are not listed in the order code below 2.1, these specifications apply accordingly, provided that they correspond to the standard version.

2.3 Purpose

The solenoid interlock has been designed to prevent in conjunction with the control part of a machine, movable safety guards from being opened before hazardous conditions have been eliminated.



Interlocks with power to lock principle may only be used in special cases after a thorough evaluation of the accident risk, since the safety guard can be opened immediately on failure of the power supply or upon activation of the main switch.



The safety switchgears are classified according to EN ISO 14119 as type 2 interlocking devices.

Manual release (for set-up, maintenance, etc.)

The manual release is realised by turning the triangular key (included in delivery) to the left (1), so that the locking bolt is pulled into the release position. The normal locking function is only restored after the triangular key has been returned to its original position (2). The manual release must be sealed after being put into operation (e.g. sealant etc.) to prevent its utilisation during operation. The manual release must not be actuated when loaded by the safety guard.

Manual release on the cover side

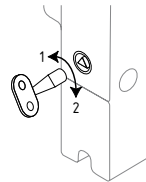

Lateral manual release (Ordering suffix E1)

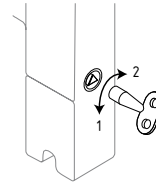

Emergency release (ordering suffix -N)

(Mounting only on the outside of the hazardous area)



The power supply of the plant must be switched off prior to opening the sealing plug.

Press the release button (1) to enable an emergency release. In this position, the safety guard can be opened. The release button latches. To neutralise the blocked condition, the sealing plug (2) must be opened. Keep the locking bolt (3) pressed with a screwdriver until the release button returns to its original position. Then put the sealing plug back and seal tight. The released condition may only be cancelled by an authorised person. The emergency release must not be used when the machinery/plant is in operation.

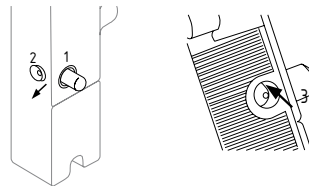

Emergency exit (Ordering suffix T)

(Fitting and actuation only from within the hazardous area)

To release an emergency exit, the release button (1) must be pressed. In this position, the safety guard can be opened. The release button latches. To neutralise the release, the reset button (2) must be pressed. In the unlocked condition, the safety guard is protected against unintentional locking.

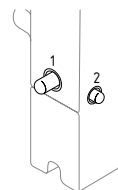



The user must evaluate and design the safety chain in accordance with the relevant standards and the required safety level.



The entire concept of the control system, in which the safety component is integrated, must be validated to the relevant standards.

2.4 Technical data

Standards:	EN 60947-5-1, EN ISO 14119
Enclosure:	glass-fibre reinforced thermoplastic
Actuator and locking bolt:	galvanised steel / zinc die-cast
Holding force F_{max} :	2,550 N
Holding force F_{Zh} :	1,950 N
Latching force:	20 N
Coding level according to EN ISO 14119:	low
Protection class:	IP67
- Ordering suffix N and T:	IP65
Contact material:	Silver
Contact type:	change-over contact with double break, or 2 NC contacts, with galvanically separated contact bridges
Switching system:	⊖ EN 60947-5-1, slow action, NC contact with positive break
Connection:	screw terminals
Cable type:	solid and stranded wire
Cable section:	0.5 - 2.5 mm ² (max. 1.5 mm ² with wire end ferrules)
Cable entry:	2 x M20
Rated impulse withstand voltage U_{imp} :	4 kV
- Device with 4 contacts or 3 contacts with LED:	1.5 kV
Rated insulation voltage U_i :	250 V
- Device with 4 contacts or 3 contacts with LED:	60 V AC
Thermal test current I_{the} :	4 A
Utilisation category:	AC-15, DC-13
Rated operating current/voltage I_e/U_e :	4 A/230 V AC 4 A/24 V DC
- Devices with 4 contacts:	4 A/24 V AC 4 A/24 V DC
- Devices with LED:	4 A/24 V DC
Max. fuse rating:	4 A gG D-fuse to EN 60269-1
Required short-circuit current:	1,000 A
Positive break travel (unlocked):	2 × 3.5 mm
Positive break force (unlocked):	20 N
Magnet switch-on time:	100 %
Rated control voltage U_s :	24 V DC, 24 V AC / 50/60 Hz, 48 V AC / 50/60 Hz, 110 V AC / 50/60 Hz, 230 V AC / 50/60 Hz
Power consumption:	max. 8.5 W
Actuating speed:	max. 20 m/min
Actuating frequency:	max. 1,200/h
Ambient temperature:	0°C ... +50°C
Mechanical life:	> 1.000.000 operations



Use copper wires only.
Tightening torque: 0.8 Nm.
Use 60/75°C wire only.
The hub shall be connected to the conduit before it is connected to the enclosure.

2.5 Safety classification of the interlocking function

Standards:	EN ISO 13849-1
Envisaged structure:	
- Basically:	applicable up to cat. 1 / PL c
- With 2-channel usage	applicable up to cat. 3 / PL d
and fault exclusion mechanism:	with suitable logic unit
B_{10D} NC contact:	2,000,000
B_{10D} NO contact at 10% ohmic contact load:	1,000,000
Mission time:	20 years

$$MTTF_D = \frac{B_{10D}}{0,1 \times n_{op}} \quad n_{op} = \frac{d_{op} \times h_{op} \times 3600 \text{ s/h}}{t_{cycle}}$$

(Determined values can vary depending on the application-specific parameters h_{op} , d_{op} and t_{cycle} as well as the load.)

If multiple safety components are wired in series, the Performance Level to EN ISO 13849-1 will be reduced due to the restricted error detection under certain circumstances.

2.6 Safety classification of the guard locking function

If the device is used as an interlock for personal safety, a safety classification of the guard locking function is required.

When classifying the interlock function, a distinction must be made between monitoring of the interlock function (locking function) and controlling the unlocking function.

The following safety classification of the unlocking function is based on the application of the principle of safety energy disconnection for the solenoid supply.



The classification of the release function is only valid for devices with monitored guard locking function and in the power to unlock version (see ordering code).

A fault exclusion for the locking device of the solenoid interlock can be assumed by a safety external energy disconnection.

In this case, the locking device of the solenoid interlock does not have an effect on the failure probability of the unlock function.

The safety level of the unlock function is determined exclusively by the external safety power shutdown.

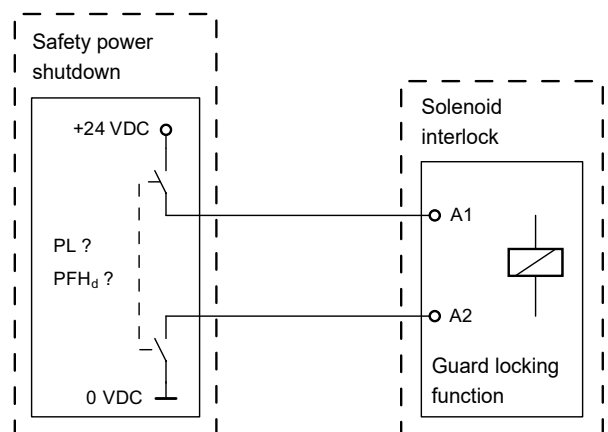

Fault exclusion with regard to wiring routing must be observed.



If for a certain application the power to unlock version of a solenoid interlock cannot be used, for this exception an interlock with power to lock can be used if additional safety measure need to be realised that have an equivalent safety level.

3. Mounting

3.1 General mounting instructions



Please observe the relevant requirements of the standards EN ISO 12100, EN ISO 14119 and EN ISO 14120.

Three mounting holes are provided for fixing the enclosure. The solenoid interlock is double insulated. The use of an earth wire is not authorised. The solenoid interlock must not be used as an end stop. Any mounting position. The components however must be mounted so that the opening of the actuating head is protected against the penetration of dirt (e.g. sand, dust, chips).

In case of painting activities, the components must be covered. In case of horizontal mounting, the cover plate (Fig. 1) situated at the back of the actuating head must be removed.

Assembly with mounting plate MP 190 and actuator AZM 190-B3 ... see Fig. 2. (Internal mounting of the interlock and mounting plate with door hinge on right-hand side).

Fig. 1

Fig. 2

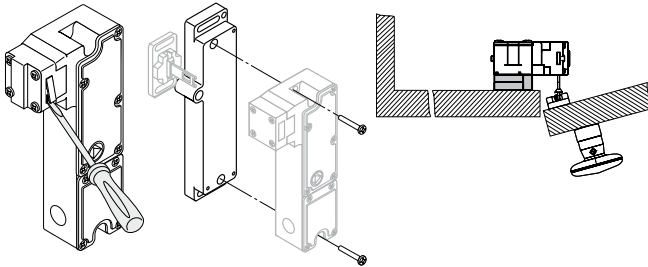

Where the door hinge is on the left, the mounting plate along with the interlock is rotated through 180°.



Alternative mounting plates that can be used in combination with actuator AZM190-B3V... especially for attaching aluminium profiles, see products.schmersal.com.

MP190-V For internal mounting with right-hinged door

MP190-VD For internal mounting with left-hinged door

By default, the key hole is at the top. If another actuating direction is desired, the four screws of the actuating head must be loosened. Turn the actuating head in the desired direction and retighten the screws (tightening torque 0.5 Nm). The default screws installed in the actuating head can be replaced with the supplied tamperproof screws.



For power-to-unlock devices the actuator must be inserted when the actuating head is turned. Any non-observance of this prescription could result in the components being damaged.



When used in ambient temperatures > 40°C, the solenoid interlock must be protected against contact with inflammable materials or inadvertent personal contact.

Mounting of the solenoid interlock and the actuator:

Refer to the mounting instructions manual for the corresponding actuator.



The actuator must be permanently fitted to the safety guards and protected against displacement by suitable measures (tamperproof screws, gluing, drilling of the screw heads).

3.2 Dimensions

All measurements in

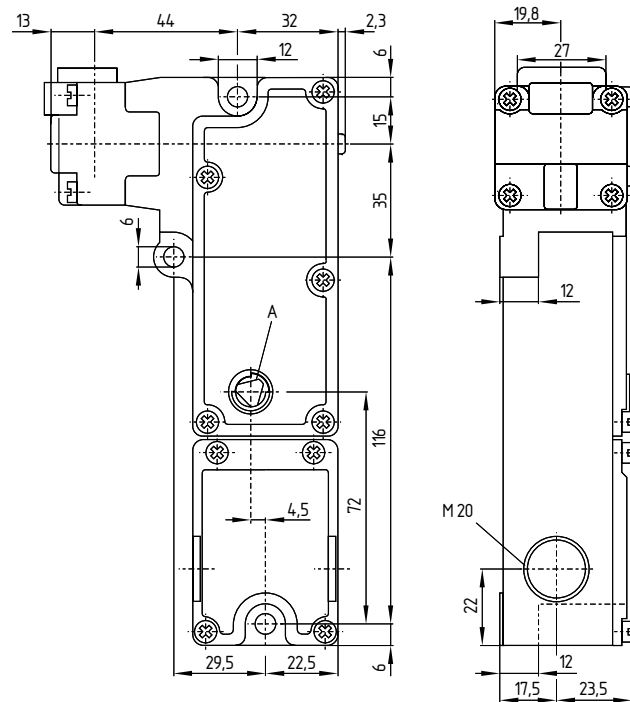

Key:

A Manual release

4. Electrical connection

4.1 General information for electrical connection



The electrical connection may only be carried out by authorised personnel in a de-energised condition.



If the risk analysis indicates the use of a monitored interlock they are to be connected in the safety circuit with the contacts indicated with the symbol .

For the cable entry, suitable cable glands with an appropriate degree of protection must be used.

Settle length x of the conductor: 6 mm



After wiring, the wiring compartment must be cleaned (i.e. remove excess cables etc.). The fixing screws of the wiring compartment cover must be tightened with 0.8 Nm tightening torque.



Devices with LED indicator for $U_e = U_s = 24 \text{ V DC}$ only. The monitoring contacts of the LED versions are not potential-free. In combination with these devices, only sequential circuits can be used, in which both channels are controlled with positive potential.



Devices with 4 contacts for $U_e = U_s = 24 \text{ V AC}$ or 24 V DC only.

4.2 Contact variants

Contacts shown in a de-energised condition and with the actuator inserted. The contact configurations of the versions with or without LED are identical.



LED display:
 YE (1) Safety guard closed
 GN (2) Safety guard closed and locked
 YE (3) Safety guard open

Power to unlock | Power to lock

AZM190-11/01RK
AZM190-11/01RKA..-G with LED

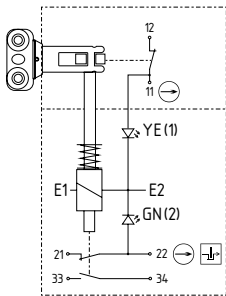

AZM190-11/01RKA
AZM190-11/01RKA..-G with LED

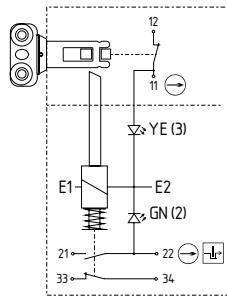

AZM190-02/10RK
AZM190-02/10RKA..-G with LED

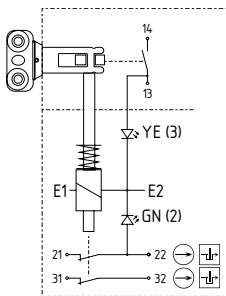

AZM190-02/10RKA
AZM190-02/10RKA..-G with LED

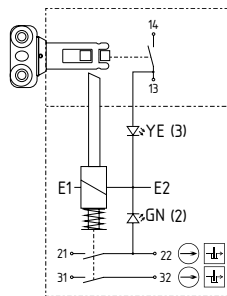

AZM190-11/10RK
AZM190-11/10RKA..-G with LED

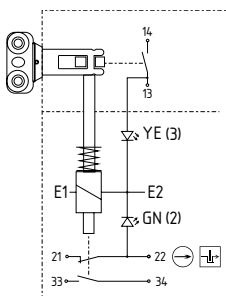

AZM190-11/10RKA
AZM190-11/10RKA..-G with LED

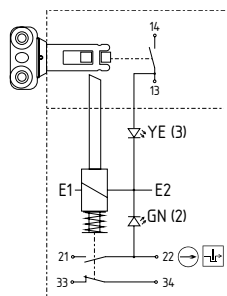

AZM190-02/01RK
AZM190-02/01RKA..-G with LED

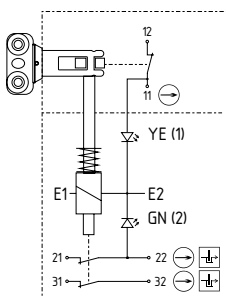

AZM190-02/01RKA
AZM190-02/01RKA..-G with LED

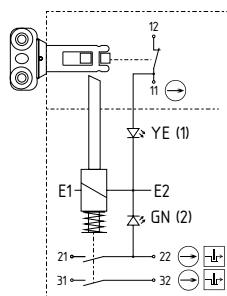

Key:

- Positive break
- Monitoring the interlock according to EN ISO 14119

Power to unlock | Power to lock

AZM190-02/02RK

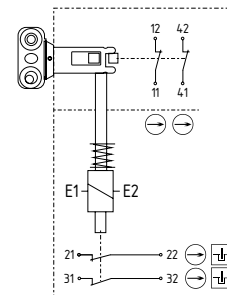

AZM190-02/02RKA

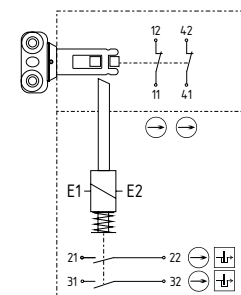

AZM190-11/02RK

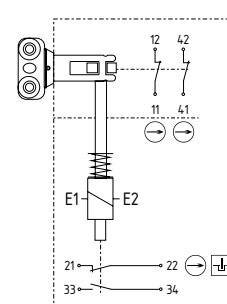

AZM190-11/02RKA

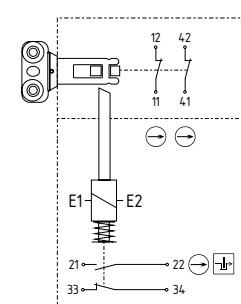

AZM190-11/11RK

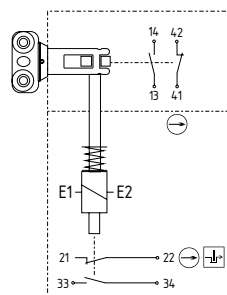

AZM190-11/11RKA

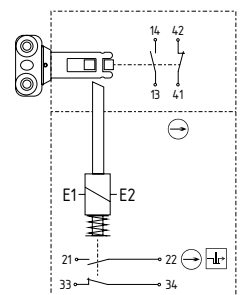

AZM190-02/11RK

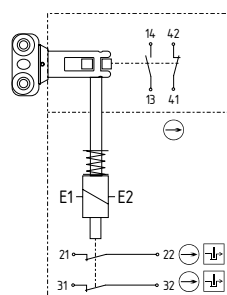

AZM190-02/11RKA

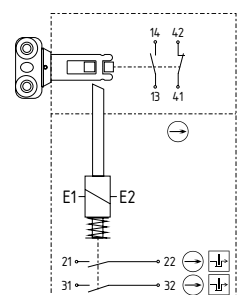

5. Set-up and maintenance

5.1 Functional testing

The safety function of the safety components must be tested. The following conditions must be previously checked and met:

1. Fitting of the solenoid interlock and the actuator.
2. Check the integrity of the cable entry and connections.
3. Check the switch enclosure for damage.

5.2 Maintenance

A regular visual inspection and functional test, including the following steps, is recommended:

1. Check for tight installation of the actuator and the switch.
2. Remove particles of dust and soiling.
3. Check cable entry and connections.



Adequate measures must be taken to ensure protection against tampering either to prevent tampering of the safety guard, for instance by means of replacement actuators.

Damaged or defective components must be replaced.

6. Disassembly and disposal

6.1 Disassembly

The safety switchgear must be disassembled in a de-energised condition only.

6.2 Disposal

The safety switchgear must be disposed of in an appropriate manner in accordance with the national prescriptions and legislations.

7. EU Declaration of conformity

EU Declaration of conformity



Original
Schmersal India Private Limited
G-7/1, MIDC, Ranjangaon
Tal. Shirur, Dist. Pune – 412 220
Maharashtra
India
Internet: www.schmersal.com

We hereby certify that the hereafter described components both in their basic design and construction conform to the applicable European Directives.

Name of the component: AZM190

Type: See ordering code

Description of the component: Interlocking device with electromagnetic interlock for safety functions (solenoid interlock)

Relevant Directives: Machinery Directive 2006/42/EC
RoHS-Directive 2011/65/EU

Applied standards: EN 60947-5-1:2017
EN ISO 14119:2013

Person authorised for the compilation of the technical documentation: Oliver Wacker
Möddinghofe 30
42279 Wuppertal

Place and date of issue: Pune, August 3, 2020

SIPL-AZM190-B-EN

Authorised signature
Sagar Jeevan Bhosale
Managing Director



The currently valid declaration of conformity can be downloaded from the internet at products.schmersal.com.



K.A. Schmersal GmbH & Co. KG
Möddinghofe 30, 42279 Wuppertal
Germany
Phone: +49 202 6474-0
Telefax: +49 202 6474-100
E-Mail: info@schmersal.com
Internet: www.schmersal.com

Production site:
Schmersal India Private Limited
G-7/1, MIDC, Ranjangaon
Tal. Shirur, Dist. Pune – 412 220
Maharashtra
India
Phone: +91 21 38 61 47 00
E-Mail: info-in@schmersal.com
Internet: www.schmersal.in