



EN Operating instructions. pages 1 to 10
Original

Content

1 About this document

1.1 Function 1

1.2 Target group: authorised qualified personnel. 1

1.3 Explanation of the symbols used 1

1.4 Appropriate use 1

1.5 General safety instructions 2

1.6 Warning about misuse 2

1.7 Exclusion of liability 2

2 Product description

2.1 Ordering code 2

2.2 Special versions. 2

2.3 Purpose 2

2.4 Technical data 2

2.5 Derating / electrical lifespan of safety contacts 3

2.6 Safety classification 3

3 Mounting

3.1 General mounting instructions 3

3.2 Dimensions 3

4 Electrical connection

4.1 General information for electrical connection. 4

4.2 Coding of connecting terminals 4

5 Operating principle and settings

5.1 Description of the terminals and LED indications 4

5.2 Adjustable applications 5

5.3 Changing setting or application 5

6 Diagnostic

6.1 LED indications 6

6.2 Faults 6

7 Wiring examples

7.1 Possible applications 6

7.2 Application example. 7

7.3 Start configuration 8

7.4 Feedback circuit / Release signal 8

7.5 Sensor configuration 8

8 Set-up and maintenance

8.1 Commissioning 9

8.2 Functional testing. 9

8.3 Behaviour in the case of faults. 9

8.4 Setting report 9

8.5 Maintenance 9

9 Disassembly and disposal

9.1 Disassembly. 9

9.2 Disposal 9

10 EU Declaration of conformity

1. About this document

1.1 Function

This operating instructions manual provides all the information you need for the mounting, set-up and commissioning for the safe operation and disassembly of the safety-monitoring module. The operating instructions must be available in a legible condition and a complete version in the vicinity of the device.

1.2 Target group: authorised qualified personnel

All operations described in this operating instructions manual must be carried out by trained specialist personnel, authorised by the plant operator only.

Please make sure that you have read and understood these operating instructions and that you know all applicable legislations regarding occupational safety and accident prevention prior to installation and putting the component into operation.

The machine builder must carefully select the harmonised standards to be complied with as well as other technical specifications for the selection, mounting and integration of the components.

1.3 Explanation of the symbols used



Information, hint, note:

This symbol indicates useful additional information.



Caution: Failure to comply with this warning notice could lead to failures or malfunctions.

Warning: Failure to comply with this warning notice could lead to physical injury and/or damage to the machine.

1.4 Appropriate use

Products in Schmersal's range are not intended to be used by private end consumers.

The products described in these operating instructions are developed to execute safety-related functions as part of an entire plant or machine. It is the responsibility of the manufacturer of a machine or plant to ensure the correct functionality of the entire machine or plant.

The safety-monitoring module must be exclusively used in accordance with the versions listed below or for the applications authorised by the manufacturer. Detailed information regarding the range of applications can be found in the chapter "Product description".

1.5 General safety instructions

The user must observe the safety instructions in this operating instructions manual, the country specific installation standards as well as all prevailing safety regulations and accident prevention rules.



Further technical information can be found in the Schmersal catalogues or in the online catalogue on the Internet: products.schmersal.com.

The information contained in this operating instructions manual is provided without liability and is subject to technical modifications.

There are no residual risks, provided that the safety instructions as well as the instructions regarding mounting, commissioning, operation and maintenance are observed.

1.6 Warning about misuse



In case of inadequate or improper use or manipulations of the safety-monitoring module, personal hazards or damage to machinery or plant components cannot be excluded.

1.7 Exclusion of liability

We shall accept no liability for damages and malfunctions resulting from defective mounting or failure to comply with this operating instructions manual. The manufacturer shall accept no liability for damages resulting from the use of unauthorised spare parts or accessories.

For safety reasons, invasive work on the device as well as arbitrary repairs, conversions and modifications to the device are strictly forbidden, the manufacturer shall accept no liability for damages resulting from such invasive work, arbitrary repairs, conversions and/or modifications to the device.

The safety relay module is to be operated in an area in which access by personnel is restricted.

2. Product description

2.1 Ordering code

This operating instructions manual applies to the following types:

SRB-E-302ST-①

No.	Option	Description
①	CC	Plug-in screw clamps: single wire (rigid) or fine wire (flexible): 0.2 ... 2.5 mm ² ; fine wire with ferrule: 0.25 ... 2.5 mm ² Plug-in cage clamps: single wire (rigid) or fine wire (flexible): 0.2 ... 1.5 mm ² ; fine wire with ferrule: 0.25 ... 1.5 mm ²



Only if the action described in these operating instructions is carried out correctly will the safety function be safeguarded, including compliance with the Machinery Directive.

2.2 Special versions

For special versions, which are not listed in the order code below 2.1, these specifications apply accordingly, provided that they correspond to the standard version.

2.3 Purpose

The safety-monitoring modules for integration in safety circuits are designed for fitting in control cabinets. They are used for the safe evaluation of the signals of positive break position switches or safety sensors for safety functions on sliding, hinged and removable safety guards as well as emergency stop control devices, safety solenoid switches and AOPD's.

The safety function is defined as deactivating outputs Q1 and 13-14, 23-24 when inputs S12 and/or S22, as well as S32 and/or S42 are opened. Taking account of a PFH value assessment, the safety-relevant current paths meet the following requirements (see also chapter 2.6 "Safety classification"):

- Category 4 – PL e to EN ISO 13849-1
- SIL 3 to IEC 61508 and EN 62061

To determine the Performance Level (PL) to EN ISO 13849-1 of the entire safety function (e.g. sensor, logic, actuator), an assessment of all relevant components is required.



The entire concept of the control system, in which the safety component is integrated, must be validated to the relevant standards.

2.4 Technical data

General data

Standards: EN 60204-1, EN 60947-5-1, EN ISO 13849-1, IEC 61508, EN 62061

EMC rating: to EMC Directive

Air clearances and creepage distances: to EN 60664-1

Mounting: standard rail to EN 60715

Terminal designations: EN 60947-1

Electrical characteristics:

Rated operating voltage U_e : 24 VDC –20%/+20%, residual ripple max. 10%

Mains unit/mains power supply: An ES1 or PELV/SELV power supply unit must be used as a voltage source or be ensured by means of additional measures so that the output voltage of the power supply in the event of an error does not exceed 60 V.

Mains power supply must harmonise with device safety (characteristic/melting property) so that triggering is ensured.

Power consumption: 3 W (+ load of the safety outputs)

Fuse rating for the operating voltage: We recommend a circuit breaker type Z (max. 16 A) or a fine fuse (max. 15 A, delayed action).

UL Rating of external fuse: max. 16 A, only use fuses in accordance with UL 248 series

Insulation values to EN 60664-1:

Rated insulation voltage U_i :

- safety contacts: 250 V

- safety outputs: 50 V

Rated impulse withstand voltage U_{imp} :

- safety contacts 13/14, 23/24: 6 kV

- safety outputs: 0.8 kV

Overvoltage category: III

Degree of pollution: 2

Pull-in delay: < 150 ms

Drop-out delay in case of "emergency stop": < 10 ms

Drop-out delay on "supply failure": < 10 ms

Bridging in case of voltage drops: typ. 5 ms

Readiness after switching on voltage: < 1.5 s

Control current circuits/inputs:

Inputs S12, S22, S32, S42: 24 VDC / 8 mA

Input X3: 24 VDC / 8 mA

Clock outputs S11, S21: > 20 VDC, 10 mA per output

Cable length: 1500 m with 1.5 mm²

2500 m with 2.5 mm²

Conduction resistance: max. 40 Ω

Relay outputs:

Switching capacity of the safety contacts: 13-14, 23-24: max. 250 V, 6 A ohmic, min. 10 VDC / 10 mA (Derating see 2.5)

Fuse rating of the safety contacts: external ($I_k = 1000 A$) to EN 60947-5-1

Safety fuse 10 A quick blow, 6 A slow blow

Utilisation category to EN 60947-5-1: AC-15: 230 V / 4 A

DC-13: 24 V / 4 A

Safety contact values:	resistance max. 100 mΩ, AgNi, self-cleaning, positive action
Electrical life:	refer to 2.5
Mechanical life:	10 million operations
Semi-conductor outputs:	
Switching capacity of the safety outputs:	Q1: max. 2 A
Voltage drop:	< 0.5 V
Leakage current:	< 1 mA
Max. fuse rating of the safety outputs:	refer to "Operating voltage"
Test impulse of the safety outputs:	< 1 ms (negative), < 100 μs (positive)
Utilisation category to EN 60947-5-1:	DC-13: 24 V / 2A
Switching capacity of signaling outputs: semi-conductor outputs Y1, Y2:	24 VDC/100 mA
Fuse rating of the signalling outputs:	internal electronic trip, tripping current > 100 mA
Electrical life:	(Derating refer to 2.5)
Mechanical life:	10 million operations
Max. switching cycles / minute:	20
Inductive consumers:	Provision is to be made for suitable protective wiring for suppression.

Mechanical data:

Connection type:	refer to 2.1
Cable section:	refer to 2.1
Connecting cable:	rigid or flexible
Tightening torque for the terminals:	0.5 Nm
Material of enclosure:	glass-fibre reinforced thermoplastic, ventilated
Weight:	180 g

Ambient conditions:

Ambient temperature:	-25°C ... +60°C (non condensing)
Storage and transport temperature:	-40°C ... +85°C (non condensing)
Degree of protection:	Enclosure: IP40 Terminals: IP20 Clearance: IP54
Resistance to shock:	30 g / 11 ms
Resistance to vibration in accordance with EN 60068-2-6:	10 ... 55 Hz, amplitude 0.35 mm
Altitude:	max. 2,000 m

2.5 Derating / electrical lifespan of safety contacts

No derating with individual installation of modules.

Derating on request if several modules are installed one after the other without spacing and with maximum output load and ambient temperatures.

Electrical life of the safety contacts

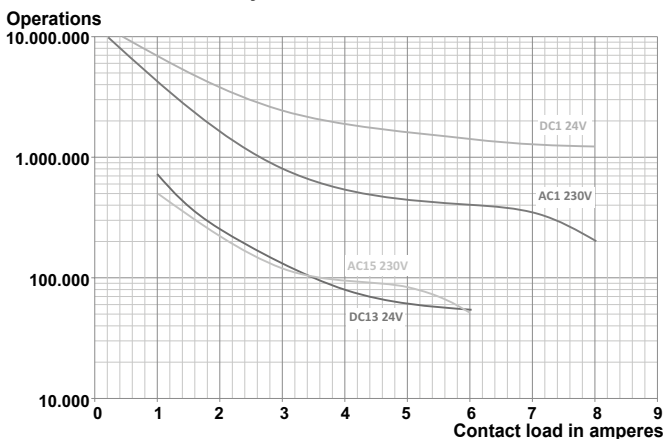

2.6 Safety classification

2.6.1 Safety classification of semi-conductor output

Standards:	EN ISO 13849-1, IEC 61508, EN 62061
PL:	e
Category:	4
PFH _D :	≤ 2.66 x 10 ⁻⁹ / h
PFD _{avg} :	≤ 2.42 x 10 ⁻⁵
SIL:	suitable for SIL 3 applications
Mission time:	20 years

2.6.2 Classification of relay output

Standards:	EN ISO 13849-1, IEC 61508, EN 62061
PL:	e
Category:	4
DC:	high
CCF:	> 65 points
PFH _D :	≤ 1.25 x 10 ⁻⁸ / h
PFD _{avg} :	≤ 5.3 x 10 ⁻⁵
SIL:	suitable for SIL 3 applications
Mission time:	20 years

The PFH value of 1.25 x 10⁻⁸/h applies to the combinations of contact load (current through enabling contacts) and number of switching cycles (n_{oply}) mentioned in the table below. At 365 operating days per year and a 24-hours operation, this results in the below-mentioned switching cycle times (t_{cycle}) for the relay contacts.

Contact load	n _{oply}	t _{cycle}
20 %	880,000	0.6 min
40 %	330,000	1.6 min
60 %	110,000	5.0 min
80 %	44,000	12.0 min
100 %	17,600	30.0 min

Diverging applications upon request.

3. Mounting

3.1 General mounting instructions

Mounting: snaps onto standard rails to EN 60715.

Hook bottom of enclosure in standard rail and push down until it engages in position.

3.2 Dimensions

Device dimensions (H/W/D): 98 x 22.5 x 115 mm

4. Electrical connection

4.1 General information for electrical connection



The electrical connection may only be carried out by authorised personnel in a de-energised condition.



If mains unit is a new installation or a replacement, the connector of the output level must be removed and correct connection of the power supply (A1) must be checked.



To avoid EMC disturbances, the physical ambient and operational conditions at the place where the product is installed, must meet the provisions laid down in the paragraph "Electromagnetic Compatibility (EMC)" of EN 60204-1.

Settle length x of the conductor:

- on screw terminals: 7 mm
- on cage clamps of type s or f: 10 mm

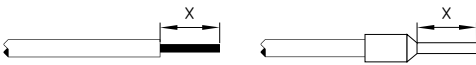

4.2 Coding of connecting terminals

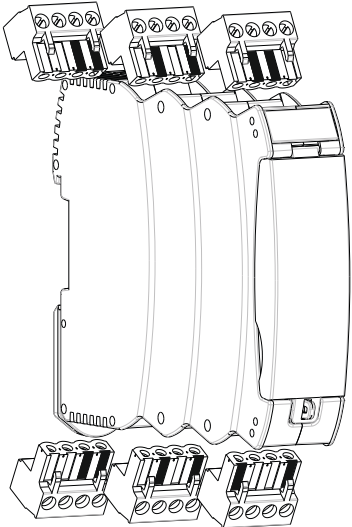

Clip	Function	LED	Function
S32	Input channel 1	In 2	Level at S32 and S42
S42	Input channel 2		For flash code, see section 6.1
Y1	Signalling output sensor 1		NC (mode 1 Pos. 1 - 6)
Y2	Signalling output sensor 2		NO (mode 1 Pos. 7 - 12)
13/14	Safety outputs	Out 1 Out 2	Outputs activated
23/24			For flash code, see section 6.1
Q1			

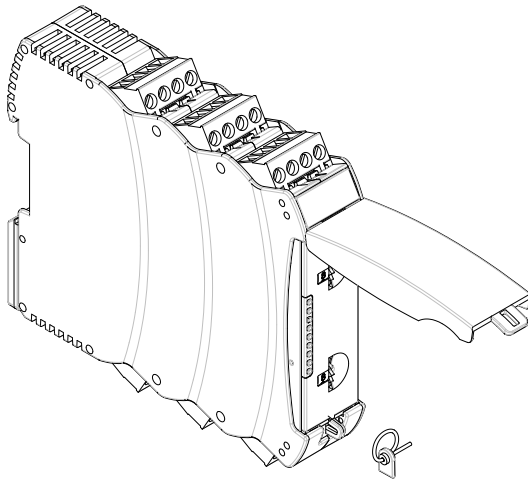
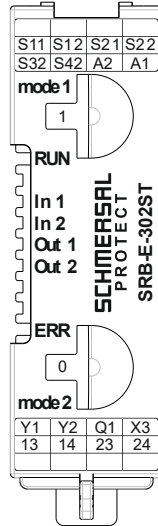

5. Operating principle and settings

5.1 Description of the terminals and LED indications

Clip	Function	LED	Function
A1	Operating voltage + 24 VDC	RUN	Operating voltage OK RUN mode For flash code, see section 6.1
A2	Operating voltage 0 V	ERR	Error code refer to part 6.2
X3	Input start circuit / feedback circuit		
S11/S21	Test pulse outputs		
S12	Input channel 1	In 1	Level at S12 and S22 For flash code, see section 6.1
S22	Input channel 2		

Adjustment of application using rotary "mode" switch

- Open front transparent cover (see fig.).
- Opening is carried out by lifting side with lock.
- Select desired application using rotary mode switch (1 ... 12) by turning up or down (see 5.3).
- After performing setting, close front cover again.
- Front cover can be secured with a lead seal to protect it from being opened unintentionally



Only touch the components after electrical discharge!

5.2 Adjustable applications

Rotary knob "mode 1"						Rotary knob "mode 2"			
Rotary knob position	Configuration sensor 1	Configuration sensor 2	Cross-wire monitoring		Configuration, signalling outputs Y1 and Y2	Autostart Position 1	Reset button with detection of the trailing edge Position 2		
			Sensor 1	Sensor 2					
1	NC/NO	NC/NO	Yes	Yes	NC	Yes	Yes		
2	NC/NC	NC/NC	Yes	Yes	NC				
3	NC/NO	NC/NC	Yes	Yes	NC				
4	NC/NO	OSSD	Yes	No	NC				
5	OSSD	OSSD	No	No	NC				
6	NC/NC	OSSD	Yes	No	NC				
7	NC/NO	NC/NO	Yes	Yes	NO				
8	NC/NC	NC/NC	Yes	Yes	NO				
9	NC/NO	NC/NC	Yes	Yes	NO				
10	NC/NO	OSSD	Yes	No	NO				
11	OSSD	OSSD	No	No	NO				
12	NC/NC	OSSD	Yes	No	NO				
13	Invalid					Yes	Yes		
14									
15									
C	Configuration mode								

5.3 Changing setting or application

Description / procedure	Rotary knob mode 1	Rotary switch mode 2	System response	LED indications			
				RUN	In 1	In 2	Out
Factory setting	Position 1	1	Ready for application 1	-	-	-	-
Switch operating voltage on	Position 1		Without connected sensors!	Lights up	-	-	-
	Turn to position C		Application 1 is deleted	Lights up	Flashes	Flashes	Flashes
Setting cycle active			Application 1 is deleted	-	-	-	-
			No valid application stored	Flashes	-	-	-
SRB-E ready for new applications							
Select application		Set start function 1 or 2	New application will be loaded	Lights up	-	-	-
	Set desired application (1 ... 12) (time window for setting procedure approx. 3 s)						
Setting cycle active				Lights up	Lights up	-	-
				Lights up	Lights up	Lights up	-
				Lights up	Lights up	Lights up	Lights up
Ready for operation	The desired application is configured		Adopt new application	Lights up	-	-	-
Switch off operating voltage and connect wires according to selected application -> SRB-E... ready for operation							

6. Diagnostic

6.1 LED indications

LED	Function	Display type
RUN	Ready for operation	Continuously lit
	Not a valid application	Flashes
In 1	Input S12 and S22 closed	Continuously lit
	Single-channel opening, S12 or S22	Flashes slowly
In 2	Input S32 and S42 closed	Continuously lit
	Single-channel opening, S32 or S42	Flashes slowly
Out 1 Out 2	Safety outputs ON	Continuously lit
	Feedback circuit not closed (input X3)	Flashes slowly

Single flashing of all LEDs with mains on

6.2 Faults

Malfunctions and fault causes are displayed with the ERR-LEDs via short and long flashing signals

LED	Error cause	Long flash	Short flash
ERR	Operating voltage too low	1	1
	Operating voltage too high	1	2
	Invalid rotary switch setting	1	3
	External voltage on output Q1	1	5, 7, 9
	Termination to GND on output Q1	2	2
	Cross-wire between inputs S12 / S22 or S32 / S42	2	4
	Undefined level on outputs:		
	S32	3	4
	S42	3	5
	X3	3	9
	S12	2	9
	S22	3	1
	Rotary switch > 30 s to position C	6	8
	Application changed and activation of operating voltage	LEDs flash quickly: RUN, In 1, In 2, Out	
	Application was changed during active operation	LEDs flash quickly: ERR, In 1, In 2, Out	
Other fault codes: Consult technical sales dept. at Schmersal			

7. Wiring examples

7.1 Possible applications

All applications for 1 or 2-channel safe evaluation for protective equipment as follows:

- Safety door monitoring to EN ISO 14119
- Position switches with positive break to EN 60947-5-1
- Safety sensors to EN 60947-5-3
- Emergency stop command devices to EN ISO 13850 and EN 60947-5-5
- Magnetic safety sensors to EN 60947-5-3
- Safety light curtain and photoelectric barriers according to EN 61496



The connection of magnetic safety switches to the SRB-E... evaluation module is only permitted when the requirements of the standard EN 60947-5-3 are observed.

As the technical data are regarded, the following minimum requirements must be met:

- Switching capacity: min. 240 mW
- Switching voltage: min. 24 VDC
- switching current: min. 10 mA



For example, the following safety sensors meet the requirements:

- BNS 36-02Z(G), BNS 36-02/01Z(G)
- BNS 260-02Z(G), BNS 260-02/01Z(G)



When sensors with LED are wired in the control circuit (protective circuit), the following rated operating voltage must be observed and respected:
• 24 VDC with a max. tolerance of -5%/+20%

Otherwise availability problems could occur, especially in series-wired sensors, where a voltage drop in the control circuit is triggered by LED's for instance.

7.2 Application example

Two-channel operation, shown using the example of two safety guard monitoring systems each with two position switches where one has a positive break contact with an external reset button

- Relay outputs: Suitable for 2-channel control, for increase in capacity or number of contacts by means of contactors or relays with positive-guided contacts
- ⊕ = Feedback circuit



Signalling outputs must not be used in safety circuits.

Wiring example

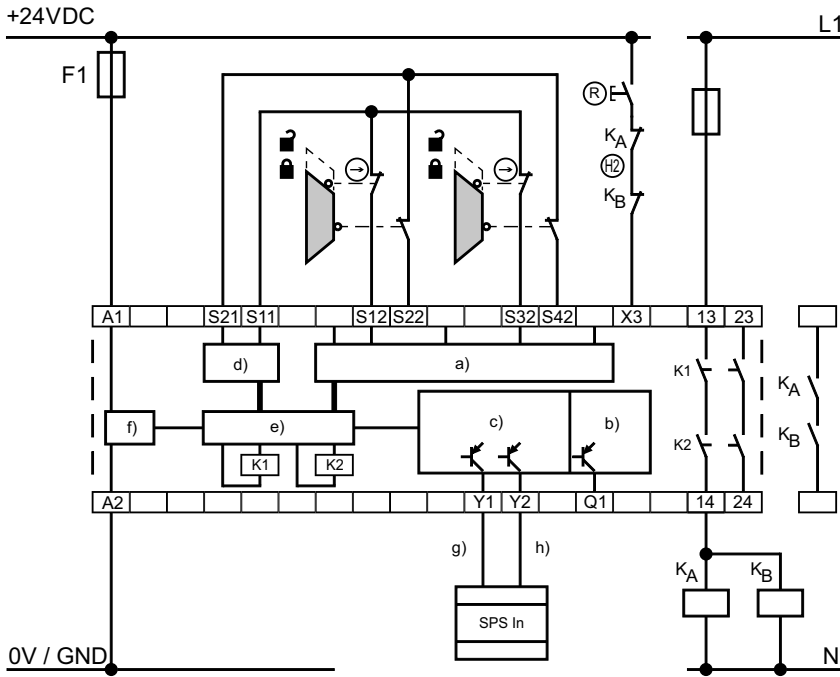

Key

- a) Safety inputs
- b) Safety outputs
- c) Signalling outputs
- d) Clock outputs
- e) Processing
- f) Power
- g) Signalling output
Status sensor 1
24 VDC / 100 mA
- h) Signalling output
Status sensor 2
24 VDC / 100 mA

7.3 Start configuration

7.3.1 Monitored start

- Manual start or activation of the module occurs when the button is released.



Monitoring of max. actuation time 0.03 s ... 3 s.
If the time is exceeded, the module cannot be started!

7.3.2 Reset without monitoring / autostart

- The manual start or the activation of the module occurs when the button is pressed (not when it is released!).
- With autostart, X3 must be bridged to S11, S21 or +24 VDC



Not admitted without additional measure due to the risk of gaining access by stepping behind!



Within the meaning of EN 60204-1 paragraph 9.2.3.4.2, the operating mode "automatic start" is only restrictedly admissible. In particular, any inadvertent restart of the machine must be prevented by other suitable measures.

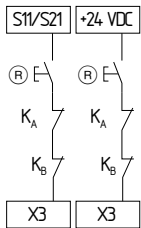

Reset button (detection of the trailing edge)

Rotary knob mode 2, position 2

Reset without monitoring / autostart

Rotary knob mode 2, position 1

7.4 Feedback circuit / Release signal

- Suitable for increase in capacity or number of contacts by means of contactors or relays with positive-guided contacts. If the feedback circuit is not required, establish a bridge.

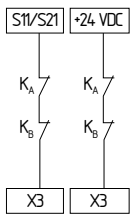

7.5 Sensor configuration

Dual channel signal processing NC / NC (2 safety sensors) with cross-circuit monitoring

(Category 4 – PL e to EN ISO 13849-1 possible)

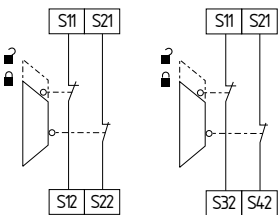

Rotary knob mode 1, position 2 and position 8

Dual channel signal processing NC / NC (1 safety sensor) with cross-circuit monitoring

(Category 4 – PL e to EN ISO 13849-1 possible)

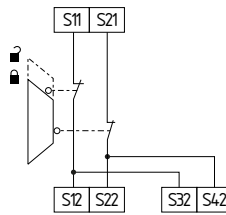

Rotary knob mode 1, position 2 and position 8

Dual channel signal processing NC / NO (2 safety sensors) with cross-circuit monitoring

(Category 4 – PL e to EN ISO 13849-1 possible)

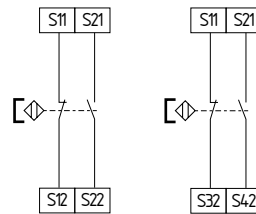

Rotary knob mode 1, position 1 and position 7

Dual channel signal processing NC / NO (1 safety sensor) with cross-circuit monitoring

(Category 4 – PL e to EN ISO 13849-1 possible)

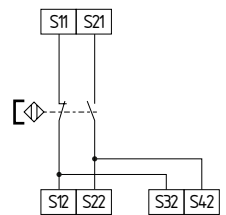

Rotary knob mode 1, position 1 and position 7

Dual channel signal processing NC / NO and NC / NC with cross-circuit monitoring

(Category 4 – PL e to EN ISO 13849-1 possible)

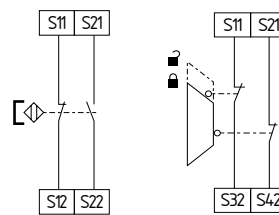

Rotary knob mode 1, position 3 and position 9

Dual channel signal processing NC / NO (1 safety sensor) with cross-circuit monitoring and OSSD

(Category 4 – PL e to EN ISO 13849-1 possible)

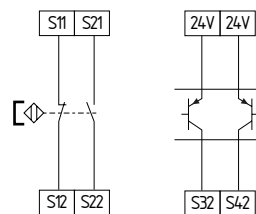

Rotary knob mode 1, position 4 and position 10

Dual channel signal processing OSSD
(2 safety sensors)
(Category 4 – PL e to EN ISO 13849-1 possible)

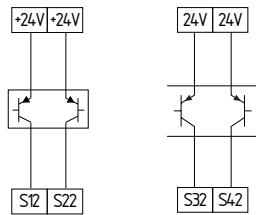

Rotary knob mode 1, position 5 and position 11

Dual channel signal processing NC / NC
with cross-circuit monitoring and OSSD
(Category 4 – PL e to EN ISO 13849-1 possible)

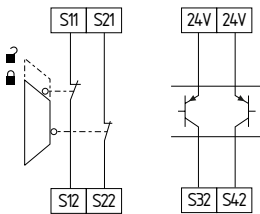

Rotary knob mode 1, position 6 and position 12

8. Set-up and maintenance

8.1 Commissioning

The safety relay module features degree of protection IP54 for installation in a switch cabinet.

The safety relay module is delivered ready for operation.

Application 1 is preset in the factory.

8.2 Functional testing

The safety function of the safety-monitoring module must be tested.

The following conditions must be previously checked and met:

1. Correct fixing
2. Check the integrity of the cable entry and connections
3. Check the safety-monitoring module's enclosure for damage
4. Check the electrical function of the connected sensor technology and their influence on the safety-monitoring module and the downstream actuators

The safety relay module features self-test functions.

If a fault is detected, the system adopts a safe mode and leads, if necessary, to undelayed deactivation of all safety outputs.

8.3 Behaviour in the case of faults

In the event of a fault the following procedure is recommended:

1. Identify faults according to flash codes from chapter 6.2.
 2. Rectify the fault if it is described in the table.
 3. Switch operating voltage off and on and erase fault mode.
- If fault could not be rectified, please contact the manufacturer.

8.4 Setting report

This report regarding the setting of the device must be completed accordingly by the customer and enclosed in the technical documentation of the machine.

The setting report must be available whenever a safety check is performed.

Company: _____

The safety-monitoring module is used in the following machine:

Machine no. _____ Machine type _____ Module n° _____

Configured application (mode 1): _____

Configured application (mode 2): _____

Set on (date) _____ Signature of the responsible person _____

8.5 Maintenance

A regular visual inspection and functional test, including the following steps, is recommended:

1. Check the correct fixing of the safety-monitoring module
2. Check the cable for damages
3. Check electrical function



If a manual functional check is necessary to detect a possible accumulation of faults, then this must take place during the intervals noted as follows:

- at least every month for PL e with category 3 or category 4 (according to EN ISO 13849-1) or SIL 3 with HFT (hardware fault tolerance) = 1 (according to EN 62061);
- at least every 12 months for PL d with category 3 (according to EN ISO 13849-1) or SIL 2 with HFT (hardware fault tolerance) = 1 (according to EN 62061).

Damaged or defective components must be replaced.

9. Disassembly and disposal

9.1 Disassembly

The safety-monitoring module must be disassembled in a de-energised condition only.

9.2 Disposal

The safety-monitoring module must be disposed of in an appropriate manner in accordance with the national prescriptions and legislations.

10. EU Declaration of conformity

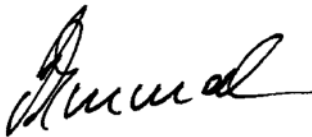
EU Declaration of conformity		
Original	K.A. Schmersal GmbH & Co. KG Möddinghofe 30 42279 Wuppertal Germany Internet: www.schmersal.com	
We hereby certify that the hereafter described components both in their basic design and construction conform to the applicable European Directives.		
Name of the component:	SRB-E-302ST	
Type:	See ordering code	
Description of the component:	Relay-safety combination for emergency stop circuits, guard door monitoring, solenoid safety switches and AOPDs	
Relevant Directives:	Machinery Directive	2006/42/EC
	EMC-Directive	2014/30/EU
	RoHS-Directive	2011/65/EU
Applied standards:	EN ISO 13849-1:2015 EN ISO 13849-2:2012 IEC 61508 parts 1-7:2010 EN 62061:2005 + Cor.:2010 + A1:2013 + A2:2015	
Notified body, which approved the full quality assurance system, referred to in Appendix X, 2006/42/EC:	TÜV Rheinland Industrie Service GmbH Am Grauen Stein, 51105 Köln ID n°: 0035	
Person authorised for the compilation of the technical documentation:	Oliver Wacker Möddinghofe 30 42279 Wuppertal	
Place and date of issue:	Wuppertal, March 14, 2023	
SRB-E-302ST-C-EN		
	Authorised signature Philip Schmersal Managing Director	



The currently valid declaration of conformity can be downloaded from the internet at products.schmersal.com.

