



EN Operating instructionspages 1 to 4
Original

Content

1 About this document

1.1 Function 1

1.2 Target group: authorised qualified personnel. 1

1.3 Explanation of the symbols used 1

1.4 Appropriate use 1

1.5 General safety instructions 1

1.6 Warning about misuse 1

2 Product description

2.1 Ordering code 2

2.2 Destination and use 2

2.3 Technical data 2

3 Mounting

3.1 General mounting instructions 2

3.2 Dimensions 2

3.3 Correct assembly position 2

4 Electrical connection

4.1 General information for electrical connection. 2

4.2 Switch travel diagrams. 2

5 Applications

5.1 Applications 3

6 Maintenance

6.1 Maintenance 3

7 Disposal

7.1 Disassembly. 3

7.2 Disposal 3

8 EU Declaration of conformity

1. About this document

1.1 Function

This operating instructions manual provides all the information you need for the mounting, set-up and commissioning to ensure the safe operation and disassembly of the product. The operating instructions must be available in a legible condition and a complete version in the vicinity of the device.

1.2 Target group: authorised qualified personnel

All operations described in this operating instructions manual must be carried out by trained specialist personnel, authorised by the plant operator only.

Please make sure that you have read and understood these operating instructions and that you know all applicable legislations regarding occupational safety and accident prevention prior to installation and putting the component into operation.

The machine builder must carefully select the harmonised standards to be complied with as well as other technical specifications for the selection, mounting and integration of the components.

1.3 Explanation of the symbols used



Information, hint, note:

This symbol is used for identifying useful additional information.



Caution: Failure to comply with this warning notice could lead to failures or malfunctions.

Warning: Failure to comply with this warning notice could lead to physical injury and/or damage to the machine.

1.4 Appropriate use

The Schmersal range of products is not intended for private consumers.

It is the responsibility of the manufacturer of a machine or plant to ensure the correct functionality of the entire machinery or plant.

The product must be exclusively used in accordance with the versions listed below or for the applications authorised by the manufacturer. Detailed information regarding the range of applications can be found in the chapter "Product description".

1.5 General safety instructions

The user must observe the safety instructions in this operating instructions manual, the country-specific installation standards as well as all prevailing safety regulations and accident prevention rules.



Further technical information can be found in the Schmersal catalogues or in the online catalogue on the Internet: products.schmersal.com.

The information contained in this operating instructions manual is provided without liability and is subject to technical modifications.

There are no residual risks, provided that the safety instructions as well as the instructions regarding mounting, commissioning, operation and maintenance are observed.

1.6 Warning about misuse



In case of inadequate or improper use or manipulations of the component, personal hazards or damage to machinery or plant components cannot be excluded.

2. Product description

2.1 Ordering code

This operating instructions manual applies to the following types:

MAF/S 441-11Y

2.2 Destination and use

Level switch is for the monitoring of the material flow in the silos and the storage container.

They can be deflected in any direction.

2.3 Technical data

Standards:	EN 60947-5-1
Enclosure:	Aluminium
Protection class:	IP65
Contact material:	Silver
Switching system:	snap action with double break
Switching elements:	snap action: change-over contact
Cable section:	max. 2.5 mm ²
Cable entry:	M20 x 1.5
Rated impulse withstand voltage U_{imp} :	4 kV
Rated insulation voltage U_i :	250 V
Thermal test current I_{the} :	16 A
Utilisation category:	AC-15: 4 A / 240 V
Max. fuse rating:	16 A gG D-fuse
Required short-circuit current:	1000 A
Contact break:	max. 2 x 6.0 mm
Switchover time:	35 ms
Bounce duration:	5 ms
Ambient temperature:	-30 ... +90°C
Mechanical life:	1 million operations
Switching frequency:	max. 3000 / h
Actuating speed:	max. 1 m/s, min. 1 mm/s

3. Mounting

3.1 General mounting instructions

Fitting is only authorised in a de-energised condition

Two mounting holes are available. The use of a protective ground wire is imperative.

3.2 Dimensions

All measurements in mm.

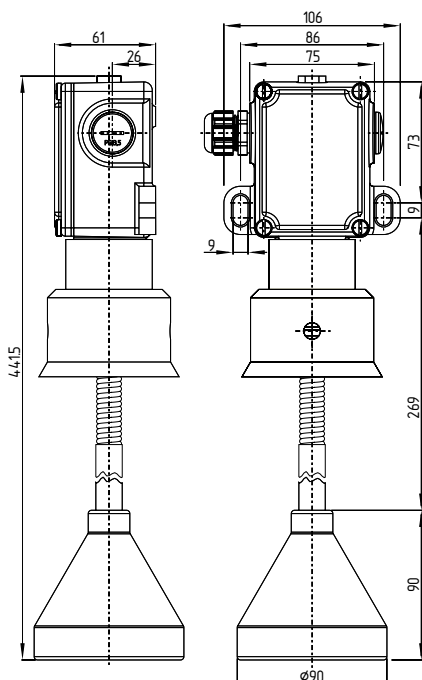

3.3 Correct assembly position



Mount the level switch away from the flow of material.

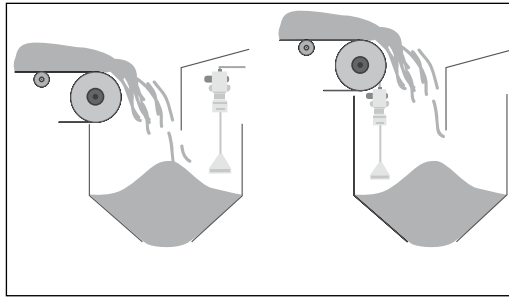

Image 1; Correct mounting

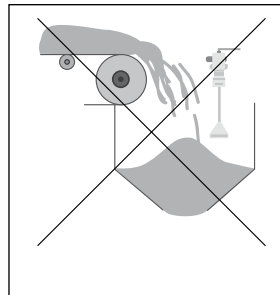

Image 2: Incorrect mounting

4. Electrical connection

4.1 General information for electrical connection



The electrical connection may only be carried out by authorised personnel in a de-energised condition.

Cable glands (included in delivery) are only authorised for permanent cables. The person installing must provide for the necessary strain relief. Unused openings must be sealed with locking screws (included in delivery).

Settle length x of the conductor: 8 mm



After wiring, the contact elements incl. enclosure must be cleaned (i.e. remove excess cables etc.).

4.2 Switch travel diagrams

Snap action

1 NO contact / 1 NC contact

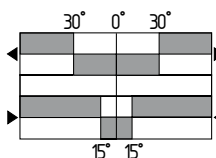

5. Applications

5.1 Applications

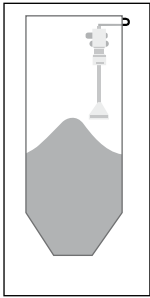

Image 3: Level monitoring silo

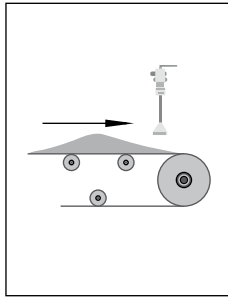

Image 4: Material flow monitoring

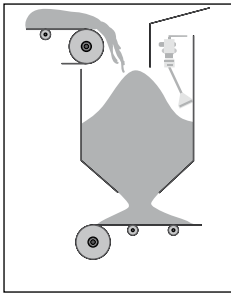

Image 5: Level monitoring transport duct

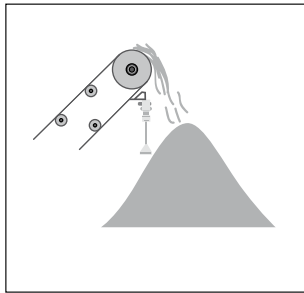

Image 6: Storage level monitoring

6. Maintenance

6.1 Maintenance

In case of correct installation in accordance with the above-described instructions, the component requires little maintenance. By use in extreme conditions, we recommend routine maintenance including the following steps:

1. Check the free movement of the actuating element
2. Remove particles of dust and soiling
3. Check the correct fixing of the cover screws
4. Check for damages and correct fixing
5. Check cable entry and connections in a de-energised condition
6. Lubricate the shaft or plunger (if necessary)

7. Disposal

7.1 Disassembly

The product must be disassembled in a de-energised condition only.

7.2 Disposal

The product must be disposed of in an appropriate manner in accordance with the national prescriptions and legislations.

8. EU Declaration of conformity

EU Declaration of conformity		
Original	SCHMERSAL Industrial Switchgear (Shanghai) Co., Ltd. Cao Ying Road 3336 201712 Shanghai / Qingpu P.R.CHINA Internet: www.schmersal.com.cn	
We hereby certify that the hereafter described components both in their basic design and construction conform to the applicable European Directives.		
Name of the component:	MAF/S 441	
Type:	See ordering code	
Description of the component:	Level switches for bulk materials	
Relevant Directives:	Low Voltage Directive RoHS-Directive	2014/35/EU 2011/65/EU
Applied standards:	EN 60947-5-1:2017 + AC:2020	
Person authorised for the compilation of the technical documentation:	Oliver Wacker Möddinghofe 30 42279 Wuppertal	
Place and date of issue:	Shanghai, August 18, 2023	
SISS-MAF/S441-B-EN		
	Authorised signature Michele Seassaro Managing Director	



The currently valid declaration of conformity can be downloaded from the internet at products.schmersal.com.



K.A. Schmersal GmbH & Co. KG
Möddinghofe 30, 42279 Wuppertal
Germany
Phone: +49 202 6474-0
Fax: +49 202 6474-100
E-Mail: info@schmersal.com
Internet: www.schmersal.com

Production site:
SCHMERSAL
Industrial Switchgear (Shanghai) Co., Ltd.
Cao Ying Road 3336
201712 Shanghai / Qingpu, P.R.CHINA
Phone: +86-21-63 75 82 87
Fax: +86-21-69 21 43 98
E-Mail: info@schmersal.com.cn
Internet: www.schmersal.com.cn