



**EN** Operating instructions. . . . .pages 1 to 4  
Original

**Content**

**1 About this document**  
 1.1 Function . . . . . 1  
 1.2 Target group: authorised qualified personnel. . . . . 1  
 1.3 Explanation of the symbols used . . . . . 1  
 1.4 Appropriate use . . . . . 1  
 1.5 General safety instructions . . . . . 1  
 1.6 Warning about misuse . . . . . 1  
 1.7 Exclusion of liability . . . . . 1

**2 Product description**  
 2.1 Ordering code . . . . . 2  
 2.2 Special versions. . . . . 2  
 2.3 Purpose . . . . . 2  
 2.4 Technical data . . . . . 2  
 2.5 Safety classification . . . . . 2

**3 Mounting**  
 3.1 General mounting instructions . . . . . 2  
 3.2 Pull wire system accessories. . . . . 3  
 3.3 Dimensions . . . . . 3

**4 Electrical connection**  
 4.1 General information for electrical connection. . . . . 4  
 4.2 Contact variant. . . . . 4  
 4.3 Switch travel diagrams. . . . . 4

**5 Set-up and maintenance**  
 5.1 Functional testing. . . . . 4  
 5.2 Maintenance . . . . . 4

**6 Disassembly and disposal**  
 6.1 Disassembly. . . . . 4  
 6.2 Disposal . . . . . 4

**7 Declaration of conformity**

**1. About this document**

**1.1 Function**  
 This operating instructions manual provides all the information you need for the mounting, set-up and commissioning to ensure the safe operation and disassembly of the safety switchgear. The operating instructions must be available in a legible condition and a complete version in the vicinity of the device.

**1.2 Target group: authorised qualified personnel**  
 All operations described in this operating instructions manual must be carried out by trained specialist personnel, authorised by the plant operator only.

Please make sure that you have read and understood these operating instructions and that you know all applicable legislations regarding occupational safety and accident prevention prior to installation and putting the component into operation.

The machine builder must carefully select the harmonised standards to be complied with as well as other technical specifications for the selection, mounting and integration of the components.

**1.3 Explanation of the symbols used**

 **Information, hint, note:**  
 This symbol is used for identifying useful additional information.

 **Caution:** Failure to comply with this warning notice could lead to failures or malfunctions.  
**Warning:** Failure to comply with this warning notice could lead to physical injury and/or damage to the machine.

**1.4 Appropriate use**  
 The Schmersal range of products is not intended for private consumers.

The products described in these operating instructions are developed to execute safety-related functions as part of an entire plant or machine. It is the responsibility of the manufacturer of a machine or plant to ensure the correct functionality of the entire machine or plant.

The safety switchgear must be exclusively used in accordance with the versions listed below or for the applications authorised by the manufacturer. Detailed information regarding the range of applications can be found in the chapter "Product description".

**1.5 General safety instructions**  
 The user must observe the safety instructions in this operating instructions manual, the country specific installation standards as well as all prevailing safety regulations and accident prevention rules.

 Further technical information can be found in the Schmersal catalogues or in the online catalogue on the Internet: [products.schmersal.com](http://products.schmersal.com).

The information contained in this operating instructions manual is provided without liability and is subject to technical modifications.

There are no residual risks, provided that the safety instructions as well as the instructions regarding mounting, commissioning, operation and maintenance are observed.

**1.6 Warning about misuse**

 In case of improper use or manipulation of the safety switchgear, personal hazards or damages to machinery or plant components cannot be excluded.

**1.7 Exclusion of liability**  
 We shall accept no liability for damages and malfunctions resulting from defective mounting or failure to comply with this operating instructions manual. The manufacturer shall accept no liability for damages resulting from the use of unauthorised spare parts or accessories.

For safety reasons, invasive work on the device as well as arbitrary repairs, conversions and modifications to the device are strictly forbidden, the manufacturer shall accept no liability for damages resulting from such invasive work, arbitrary repairs, conversions and/or modifications to the device.

## 2. Product description

### 2.1 Ordering code

This operating instructions manual applies to the following types:

**T3Z 068-①YR②③**

| No. | Option | Description            |
|-----|--------|------------------------|
| ①   | 11     | 1 NO / 1 NC            |
|     | 22     | 2 NO / 2 NC            |
|     | 33     | 3 NO / 3 NC            |
| ②   | S      | Reset by pull ring     |
|     | S      | Reset by key           |
| ③   |        | without indicator lamp |
|     | G      | with indicator lamp    |



Only if the information described in this operating instructions manual are realised correctly, the safety function and therefore the compliance with the Machinery Directive is maintained.

### 2.2 Special versions

For special versions, which are not listed in the order code below 2.1, these specifications apply accordingly, provided that they correspond to the standard version.

### 2.3 Purpose

Pull-wire emergency stop switches are used wherever it must be possible to initiate the emergency stop command from any point on a machine, equipment or plant. The emergency stop command is triggered by pulling on the tensioned pull-wire.

The pull-wire Emergency Stop switch has wire-breakage monitoring. On pulling or breakage of the wire, the NC contacts are positively opened and the NO contacts are closed. Thereafter the pull-wire emergency switch can only be manually set back into an operational state.



The entire concept of the control system, in which the safety component is integrated, must be validated to the relevant standards.

### 2.4 Technical data

|   |  |
|---|--|
| Standards:                                  | DIN EN 60947-5-1, DIN EN 60947-5-5,<br>DIN EN ISO 13850, EN 620                      |
| Enclosure:                                  | Grey cast iron, painted  |
| Cover:                                      | Grey cast iron, painted  |
| Degree of protection:                       | IP65 to EN 60529   |
| Contact material:                           | Silver   |
| Contact type:                               | change-over contact with double break,<br>max. 3 NO and 3 NC contacts                |
| Switching system:                           | ⊖ DIN EN 60947-5-1 snap action,<br>NC contacts with positive break                   |
| Connection:                                 | screw terminals  |
| Cable section:                              | 0.75 ... 1.5 mm <sup>2</sup> ,<br>solid and stranded wire<br>with conductor ferrules |
| Cable entry:                                | 2 x M20  |
| Rated impulse withstand voltage $U_{imp}$ : | 4 kV   |
| Overvoltage category:                       | III  |
| Degree of pollution:                        | 2  |
| Rated insulation voltage $U_i$ :            | 250 VAC  |
| Thermal test current $I_{the}$ :            | 10 A   |
| Utilisation category:                       | AC-15, DC-13   |
| Rated operating current/voltage $I_e/U_e$ : | 2.5 A / 230 VAC<br>6 A / 24 VDC  |
| Max. fuse rating:                           | 6 A gG D-fuse  |
| Required short-circuit current:             | 1,000 A  |
| Positive break torque:                      | 1.8 Nm   |
| Angle for positive break travel:            | 32°  |
| Positive break force:                       | 50 N   |

|                       |  |
|-----------------------|--|
| Actuating force:      | max. 50 N,<br>(30 N in wire direction)       |
| Ambient temperature:  | -30 °C ... +90 °C                            |
| Mechanical life:      | 50,000 operations                            |
| Indicator lamp:       | yellow 230 VAC / 5 W,<br>screw socket BA 15D |
| Maximum cable length: | 2 x 50 m                                     |
| Features:             | wire pull and breakage detection             |



Temperature rating of field installed conductors min. 90°C.  
Use copper conductors only.

### 2.5 Safety classification

|                       |                |
|-----------------------|----------------|
| Standards:            | EN ISO 13849-1 |
| $B_{10D}$ NC contact: | 100,000        |
| Mission time:         | 20 years       |

$$MTTF_D = \frac{B_{10D}}{0,1 \times n_{op}} \quad n_{op} = \frac{d_{op} \times h_{op} \times 3600 \text{ s/h}}{t_{cycle}}$$

(Determined values can vary depending on the application-specific parameters  $h_{op}$ ,  $d_{op}$  and  $t_{cycle}$  as well as the load.)

If multiple safety components are wired in series, the Performance Level to EN ISO 13849-1 will be reduced due to the restricted error detection under certain circumstances.

## 3. Mounting

### 3.1 General mounting instructions



The installation may only be carried out with the system de-energised and by authorised personnel.

The pull-wire emergency stop switch must be fitted in the middle of the plant. Four mounting holes are available. Mount the pull-wire emergency stop switch so that the device can be unlocked and reset by hand after an emergency stop command.



In accordance with DIN EN 60947-5-5 (EN 620), the maximum perpendicular traction force to be exercised on the wire in order to activate the emergency pull-wire switch is 200 N, the maximum deflection is 400 mm. Sufficient space must be provided so that the required actuating deflection can be reached. It must be ensured that when tensioned, the wire rope always follows a straight course and that it remains in the correct position at all times (including at the redirection point). External influences (temperature variations, ageing) could cause the wire rope to be altered. The information in DIN EN ISO 13850 must be observed.

### 3.2 Pull wire system accessories

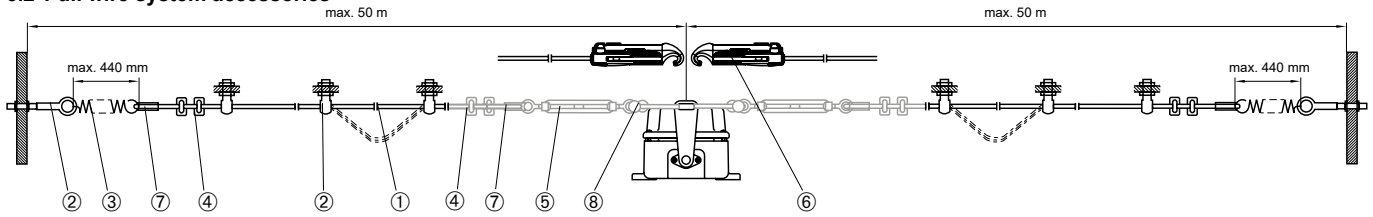

Equip the wire rope ① at the connection points with a thimble ⑦ and two wire clamps ④. The first wire clamp must be installed immediately behind the thimble. The PVC sheath of the pull wire must be stripped in the thimble area. Adjust the pre-tension of the springs ③ by means of the tensioning jack ⑤/ rope tensioner ⑥ so that the lever is in the middle position and the counterside triggers the emergency stop command in case of breakage of the wire rope. The tension spring contains elongation protection.



Switch travel x: max. 400 mm  
Stroke limitation A: 70 mm  
Distance between support points L: max. 3 m



The greyed out components ④, ⑤, ⑦ and ⑧ are not required if using the rope tensioner S 900.

| No. | Description  | Designation            | Ordering code | Details  |
|-----|--|------------------------|---------------|--|
| ①   | Wire rope  | PWR-xM                 | on request    | Red PVC sheath, steel core Ø 3 mm, Total diameter 5 mm |
| ②   | Eyebolt<br>(incl. nut)<br>Anchoring hook<br>(incl. 2 nuts and washers)                               | ACC-PWR-EBLT-BM8X70-A2 | 101192471     | Stainless steel,                                       |
|     |  | ACC-PWR-EBLT-BM10X40   | 101084928     | steel, galvanised                                      |
|     |  | ACC-EBLT-M8-RVA-5PCS   | 103031496     | Stainless steel, 5 pieces                              |
|     |  | ACC-EBLT-M10-RVA-5PCS  | 103031499     | Stainless steel, 5 pieces                              |
|     |  | ACC-EBLT-M8-5PCS       | 103031495     | Galvanised steel, 5 pieces                             |
| ③   | Tension spring   | ACC-EBLT-M10-5PCS      | 103031498     | Galvanised steel, 5 pieces                             |
|     |  | ACC-700-RZ173I         | 103005863     | Stainless steel  |
| ④   | Wire clamp   | ACC-PWR-RC-3MM-NIRO    | 101203477     | Stainless steel  |
|     |  | ACC-PWR-RC-5MM-NIRO    | 101203478     | Stainless steel  |
| ⑤   | Tensioning Jack  | ACC-TBLE-RVA           | 103031494     | M8 (stainless steel), 180 to 250 mm                    |
|     |  | ACC-PWR-TB-M6-2        | 101087930     | M6 (steel, galvanised), 145 to 225 mm                  |
| ⑥   | Rope tensioner   | S 900                  | 101186704     | Smooth and time-saving adjustment                      |
| ⑦   | Wire thimble   | ACC-PWR-WT-3MM-NIRO    | 101203472     | Stainless steel  |
|     |  | ACC-PWR-WT-5MM-NIRO    | 101203476     | Stainless steel  |
| ⑧   | Shackle<br>Mounting set, double-sided<br>Mounting set, double-sided with quick-clamping system S 900 | ACC-PWR-SKL-A0,16-VA   | 101186490     | Bracket with threaded bolt, stainless steel            |
|     |  | ACC-RK-RS65X           | 103036965     | 2x ②, ③, ⑤ and 4x ⑦, ⑧ and 8x ④ in each case           |
|     |  | ACC-RK-RS65X-QR        | 103036963     | 2x ②, ③, ⑥, ⑦ and 4x ④ in each case                    |

### Other accessories

| Description      | Designation        | Ordering code |
|------------------|--------------------|---------------|
| Actuating handle | ACC-PWR-HDL        | 103042171     |
| Pulley           | ACC-PWR-PLY        | 103037516     |
| Marking flag     | ACC-PWR-ESLB-50PCS | 103032469     |

### Deformation of the wire thimbles

As the thimbles are subject to deformation in case of wire pull, the wire should be pulled several times after fitting. After that, the wire must be re-tensioned (see image 3).

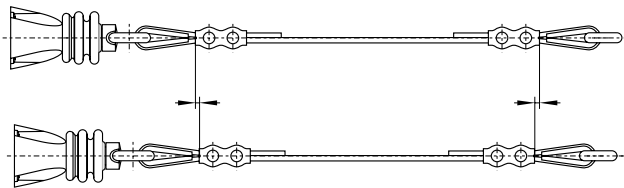

### 3.3 Dimensions

All measurements in mm.

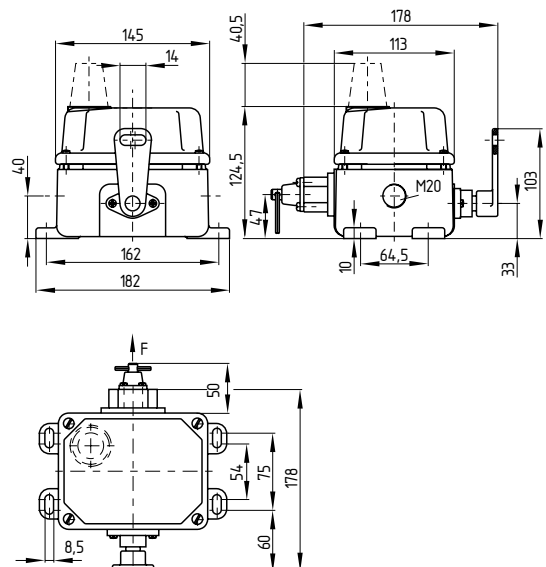

### 4. Electrical connection

#### 4.1 General information for electrical connection



The electrical connection may only be carried out by authorised personnel in a de-energised condition.

For the cable entry, suitable cable glands with an appropriate degree of protection must be used. Non-used input openings must be sealed by means of threaded plugs.

Settle length **x** of the conductor: 4 mm



The optional indicator lamp must be connected with insulated push-on (faston) receptacles 6.35 x 0.8 mm. After wiring, the cover screws must be tightened uniformly.

#### 4.2 Contact variant

All NC contacts have positive break  $\ominus$ .

1 NO / 1 NC

T3Z 068-11YR

T3Z 068-11YRS

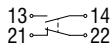

2 NO / 2 NC

T3Z 068-22YR

T3Z 068-22YRS

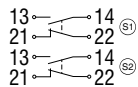

3 NO / 3 NC

T3Z 068-33YR

T3Z 068-33YRS

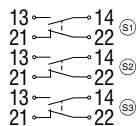

#### 4.3 Switch travel diagrams

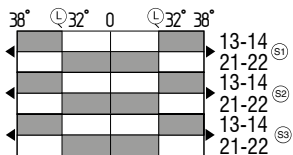
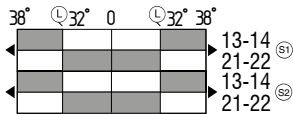
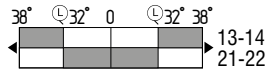

#### Legende:

Ⓢ1, Ⓢ2, Ⓢ3 Switch insert S1, S2, S3

■ Contact closed

□ Contact open

Ⓛ Latching

### 5. Set-up and maintenance

#### 5.1 Functional testing

The safety function of the safety components must be tested.

The following conditions must be previously checked and met:

1. Check the correct fitting of the pull-wire emergency stop switch
2. Check the integrity of the cable entry and connections
3. Check the functionality of the switch by actuating the wire

#### 5.2 Maintenance

In case of correct installation in accordance with the above-described instructions, the component requires little maintenance. For use in extreme conditions, we recommend routine maintenance including the following steps:

1. Actuate the lever to check its free movement
2. Check the correct latching after actuation of the pull-wire emergency stop switch
3. Remove particles of dust and soiling
4. Check the wire rope (and any redirection rollers) for damage and correct seating.
5. Check cable entry and connections

Damaged or defective components must be replaced.

### 6. Disassembly and disposal

#### 6.1 Disassembly

The safety switchgear must be disassembled in a de-energised condition only.

#### 6.2 Disposal



The safety switchgear must be disposed of in an appropriate manner in accordance with the national prescriptions and legislations.

### 7. Declaration of conformity

We hereby certify that the hereafter described components both in their basic design and construction conform to the applicable European Directives.

#### Relevant Directives:



2006/42/EC  
2011/65/EU

#### Applied standards:

DIN EN 60947-5-1:2018  
DIN EN 60947-5-5:2017  
DIN EN ISO 13850:2016



The currently valid declaration of conformity can be downloaded from the internet at [products.schmersal.com](http://products.schmersal.com).

**K.A. Schmersal GmbH & Co. KG**  
Mödinghofe 30, 42279 Wuppertal  
Germany  
Phone: +49 202 6474-0  
Fax: +49 202 6474-100  
E-Mail: [info@schmersal.com](mailto:info@schmersal.com)  
Internet: [www.schmersal.com](http://www.schmersal.com)

**Production site:**  
**Schmersal India Private Limited**  
G-7/1, MIDC, Ranjangaon  
Taluka Shirur, Dist. Pune – 412 220  
Maharashtra  
India  
Phone: +91 21 38614700  
E-Mail: [info-in@schmersal.com](mailto:info-in@schmersal.com)  
Internet: [www.schmersal.in](http://www.schmersal.in)