



**EN** Operating instructions. . . . .pages 1 to 6  
Original

**Content**

**1 About this document**

1.1 Function . . . . . 1

1.2 Target group: authorised qualified personnel. . . . . 1

1.3 Explanation of the symbols used . . . . . 1

1.4 Appropriate use . . . . . 1

1.5 General safety instructions . . . . . 1

1.6 Warning about misuse . . . . . 1

1.7 Exclusion of liability . . . . . 2

**2 Product description**

2.1 Ordering code . . . . . 2

2.2 Special versions. . . . . 2

2.3 Purpose . . . . . 2

2.4 Bestimmung und Gebrauch für den Explosionsschutz . . . . . 2

2.5 Technical Data . . . . . 2

2.6 Safety classification of the interlocking function. . . . . 3

2.7 Safety classification of the interlock function . . . . . 3

**3 Assembly**

3.1 General mounting instructions . . . . . 3

3.2 Dimensions . . . . . 4

3.3 Solenoid interlock with protective enclosure . . . . . 4

3.4 Mounting of individually coded actuators. . . . . 4

**4 Electrical connection**

4.1 General information for electrical connection. . . . . 5

4.2 Contact Options . . . . . 5

**5 Set-up and maintenance**

5.1 Functional testing. . . . . 6

5.2 Maintenance . . . . . 6

**6 Disassembly and disposal**

6.1 Disassembly. . . . . 6

6.2 Disposal . . . . . 6

**7 EU Declaration of conformity**

**1. About this document**

**1.1 Function**

This operating instructions manual provides all the information you need for the mounting, set-up and commissioning to ensure the safe operation and disassembly of the safety switchgear. The operating instructions must be available in a legible condition and a complete version in the vicinity of the device.

**1.2 Target group: authorised qualified personnel**

All operations described in this operating instructions manual must be carried out by trained specialist personnel, authorised by the plant operator only.

Please make sure that you have read and understood these operating instructions and that you know all applicable legislations regarding occupational safety and accident prevention prior to installation and putting the component into operation.

The machine builder must carefully select the harmonised standards to be complied with as well as other technical specifications for the selection, mounting and integration of the components.

**1.3 Explanation of the symbols used**



**Information, hint, note:**

This symbol indicates useful additional information.



**Caution:** Failure to comply with this warning notice could lead to failures or malfunctions.

**Warning:** Failure to comply with this warning notice could lead to physical injury and/or damage to the machine.

**1.4 Appropriate use**

The Schmersal range of products is not intended for private consumers.

The products described in these operating instructions are developed to execute safety-related functions as part of an entire plant or machine. It is the responsibility of the manufacturer of a machine or plant to ensure the correct functionality of the entire machine or plant.

The safety switchgear must be exclusively used in accordance with the versions listed below or for the applications authorised by the manufacturer. Detailed information regarding the range of applications can be found in the chapter "Product description".

**1.5 General safety instructions**

The user must observe the safety instructions in this operating instructions manual, the country specific installation standards as well as all prevailing safety regulations and accident prevention rules.



Further technical information can be found in the Schmersal catalogues or in the online catalogue on the Internet: [products.schmersal.com](http://products.schmersal.com).

The information contained in this operating instructions manual is provided without liability and is subject to technical modifications.

There are no residual risks, provided that the safety instructions as well as the instructions regarding mounting, commissioning, operation and maintenance are observed.

**1.6 Warning about misuse**



In case of improper use or manipulation of the safety switchgear, personal hazards or damages to machinery or plant components cannot be excluded.

### 1.7 Exclusion of liability

We shall accept no liability for damages and malfunctions resulting from defective mounting or failure to comply with this operating instructions manual. The manufacturer shall accept no liability for damages resulting from the use of unauthorised spare parts or accessories.

For safety reasons, invasive work on the device as well as arbitrary repairs, conversions and modifications to the device are strictly forbidden, the manufacturer shall accept no liability for damages resulting from such invasive work, arbitrary repairs, conversions and/or modifications to the device.

## 2. Product description

### 2.1 Ordering code

This operating instructions manual applies to the following types:

#### EX-AZM 161①-12/12②③④-024-⑤-3D

No.	Option	Description
①	CC	Cage clamps
	SK	Screw Terminals
②		Latching force 5 N
	R	Latching force 30 N
③	K	Standard coded (Actuator not included in delivery)
	I	Individually coded (incl. actuator, see ⑤)
④		Power to unlock
	A	Power to lock
⑤	B1	Actuator B1 included
	B1E	Actuator B1E included
	B6L	Actuator B6 included for door hinge on left-hand side
	B6R	Actuator B6 included for door hinge on right-hand side
	B1-1747	Actuator B1-1747 included
	B1-2024	Actuator B1-2024 included
	B1-2053	Actuator B1-2053 included
	B1-2177	Actuator B1-2177 included



Only if the information described in this operating instructions manual are realised correctly, the safety function and therefore the compliance with the Machinery Directive and the Explosion Protection Directive is maintained.

### 2.2 Special versions

For special versions, which are not listed in the order code below 2.1, these specifications apply accordingly, provided that they correspond to the standard version.

### 2.3 Purpose

The solenoid interlock has been designed to prevent in conjunction with the control part of a machine, movable safety guards from being opened before hazardous conditions have been eliminated.

The EX-AZM 161 I solenoid interlocks with individual coding offer a higher protection against tampering.



Interlocks with power to lock principle may only be used in special cases after a thorough evaluation of the accident risk, since the safety guard can be opened immediately on failure of the power supply or upon activation of the main switch.



The safety switchgears are classified according to EN ISO 14119 as type 2 interlocking devices. Designs with individual coding are classified as highly coded.



The user must evaluate and design the safety chain in accordance with the relevant standards and the required safety level.



The entire concept of the control system, in which the safety component is integrated, must be validated to the relevant standards.

### 2.4 Bestimmung und Gebrauch für den Explosionsschutz

The components can be used in potentially explosive atmospheres of Zone 22 equipment category 3D. The installation and maintenance requirements to the standard series 60079 must be met.

### Conditions for safe operation

Due to the specific impact energy, the components must be fitted with a protection against mechanical stresses. The specific ambient temperature range must be observed. The user must provide for a protection against the permanent influence of UV rays.

### 2.5 Technical Data

Designation in accordance with the ATEX Directive:	Ⓜ II 3D
Designation in accordance with standards:	Ex tc IIIC T80°C Dc X
Applied standards:	EN 60947-5-1, EN ISO 14119, EN IEC 60079-0, EN 60079-31
Enclosure:	glass-fibre reinforced thermoplastic, self-extinguishing
Protective enclosure:	Metal, coated
Actuator and locking bolt:	stainless steel 1.4301
Holding force $F_{max}$ :	2,600 N
Holding force $F_{Zh}$ :	2,000 N
Latching force:	30 N for ordering suffix R
Coding level according to EN ISO 14119:	
- Standard coding version:	low
- Individual coding version:	high
Degree of protection:	IP67 to EN 60529, IP64 to the standard series 60079
Contact material:	Silver
Contact type:	Change-over contact with double break type Zb, with galvanically separated contact bridges
Switching system:	Ⓜ acc. EN 60947-5-1 slow action, NC contact with positive break
Connection:	screw terminals or cage clamps
Cable type:	rigid single-wire or flexible
Max. cable section:	0.25 ... 1.5 mm <sup>2</sup> (incl. conductor ferrules)
Cable entry:	4 x M16
Positive break travel (unlocked):	10 mm
Positive break force (unlocked):	10 N for each NC contact fitted
Actuating speed:	max. 1 m/s
Actuating frequency:	max. 1,000 operations/h
Mechanical life:	max. 1,000,000 operations
Ambient temperature:	-10 °C ... +50 °C
Max. impact energy:	without mechanical protective enclosure: 1 J with mechanical enclosure: 7 J
Tightening torque:	
- Cover screws:	min. 0.6 Nm
- Cable gland / locking screws:	3 Nm
Cable glands:	Ⓜ II 2GD
Cable cross-section:	Ø 5 ... 10 mm
<b>Electrical data:</b>	
Utilisation category:	DC-13
Rated operating current/voltage $I_g/U_g$ :	4 A / 24 VAC
Rated impulse withstand voltage $U_{imp}$ :	4 kV
Rated insulation voltage $U_i$ :	250 V
Thermal test current $I_{me}$ :	6 A
Max. fuse rating:	6 A gG D-fuse
Required rated short-circuit current:	1,000 A
Rated control voltage $U_c$ :	24 VDC 24 VAC / 50/60 Hz
<b>Electrical data – Magnet control:</b>	
Magnet switch-on time:	100 %
Power consumption:	max. 10 W
Accepted test pulse duration on input signal:	≤ 5.0 ms
- With test pulse interval of:	≥ 50 ms

### 2.6 Safety classification of the interlocking function

Standards: EN ISO 13849-1

Envisaged structure:

- Basically: applicable up to Cat. 1 / PL c
- With 2-channel usage and fault exclusion mechanism\*: applicable up to Cat. 3 / PL d with suitable logic unit

B<sub>10D</sub> NC contact: 2,000,000

Electrical life: on request

B<sub>10D</sub> NO contact at 10% ohmic contact load: 1,000,000

Mission time: 20 years

\* If a fault exclusion to the 1-channel mechanics is authorised.

$$MTTF_D = \frac{B_{10D}}{0,1 \times n_{op}} \quad n_{op} = \frac{d_{op} \times h_{op} \times 3600 \text{ s/h}}{t_{cycle}}$$

(Determined values can vary depending on the application-specific parameters hop, dop and t<sub>cycle</sub> as well as the load.)

If multiple safety components are wired in series, the Performance Level to EN ISO 13849-1 will be reduced due to the restricted error detection under certain circumstances.

### 2.7 Safety classification of the interlock function

If the device is used as an interlock for personal safety, a safety classification of the guard locking function is required.

When classifying the interlock function, a distinction must be made between monitoring of the interlock function (locking function) and controlling the unlocking function.

The following safety classification of the unlocking function is based on the application of the principle of safety energy disconnection for the solenoid supply



The classification of the release function is only valid for devices with monitored guard locking function and in the power to unlock version (see ordering code).

A fault exclusion for the guard locking function can be assumed by an external safety energy disconnection

In this case, the guard locking function does not have an effect on the failure probability of the unlock function.

The safety level of the unlock function is determined exclusively by the external safety power shutdown.

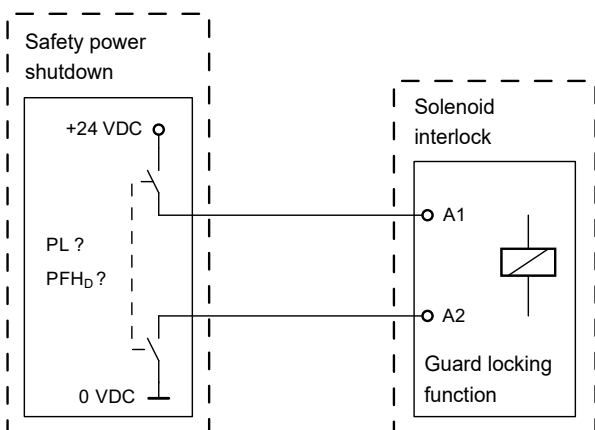

Fault exclusion with regard to wiring routing must be observed.



If for a certain application the power to unlock version of a solenoid interlock cannot be used, for this exception an interlock with power to lock can be used if additional safety measure need to be realised that have an equivalent safety level.

## 3. Assembly

### 3.1 General mounting instructions



Fitting is only authorised in a de-energised condition

Three mounting holes are provided for fixing the enclosure.

The solenoid interlock is double insulated. The use of an earth wire is not authorised. The solenoid interlock must not be used as an end stop. Any mounting position. The mounting position however must be chosen so that the ingress of dirt and soiling in the used opening is avoided. Unused actuator openings must be sealed with slot sealing plugs.



Detailed information on actuators with standard coding (not included in delivery) and their mounting can be found in the actuator operating instructions.



Please observe the remarks of the standards EN ISO 12100, EN ISO 14119 and EN ISO 14120.

### Manual release

(for set-up, maintenance, etc.)

The manual release is realised by turning the triangular key by 180°, so that the locking bolt is pulled into the unlocking position. Please ensure that jamming by external influence on the actuator is avoided. The normal locking function is only restored after the triangular key has been returned to its original position. After being put into operation, the manual release must be secured by installing the plastic cover, which is included in delivery.

### Lateral manual release

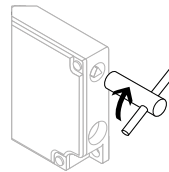

Triangular key TK-M5 (101100887) available as accessory.

### 3.2 Dimensions

All measurements in mm.

#### Solenoid interlock EX-AZM 161

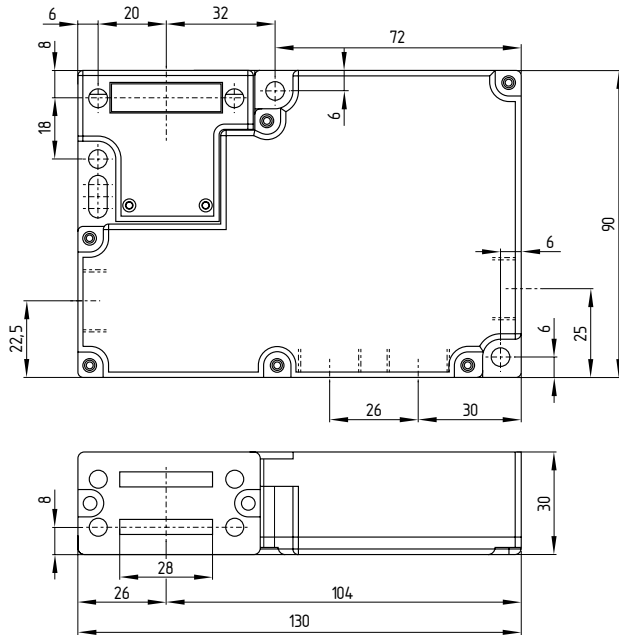

### 3.3 Solenoid interlock with protective enclosure



The solenoid interlock must be mechanically protected. In order to provide for increased mechanical protection (7 J impact resistance), the solenoid interlock must be fitted with the additional protective enclosure.

#### Fitting of the additional mechanical protective enclosure

- Fit the base plate
- Fix the solenoid interlock
- Fix the protective cover by means of 2 screws

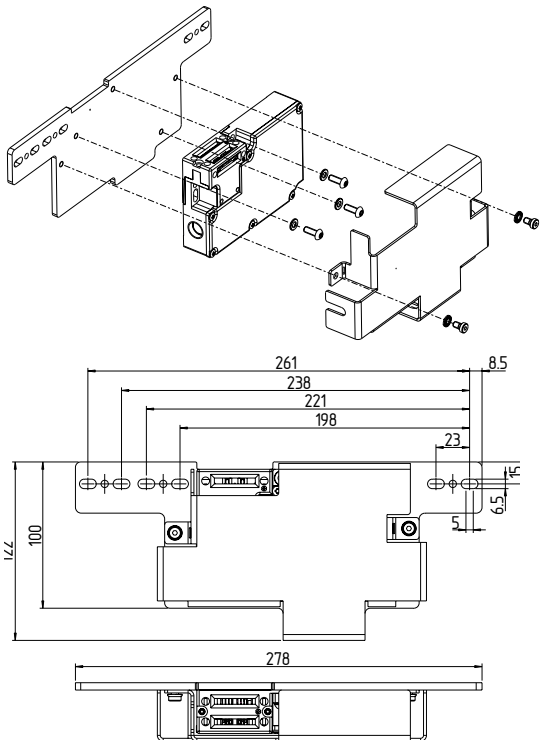

### 3.4 Mounting of individually coded actuators

(included in delivery)



In the as-delivery condition, the actuator of the individually coded solenoid interlock is inserted in the upper actuator inlet. On delivery, the actuator is in inserted condition. For power-to-unlock components, the actuator must be released by means of the manual release. If the triangular key is turned 180°, the locking bolt is pulled into the unlocking position. The normal locking function is only restored after the triangular key has been returned to its original position.



The marks on the used actuator opening of the solenoid interlock and on the actuator must be opposite.

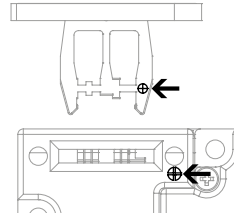

The actuator must be permanently fitted to the safety guards and protected against displacement by suitable measures (tamperproof screws, gluing, drilling of the screw heads).

Please observe that, when fixing the switch e.g. by means of rivetting or welding, the insertion depth of the actuator is not modified.

Different actuator models are available: for sliding and removable safety guards, preferably use the AZM 161-B1 and AZM 161-B1E actuator. For hinged guards, the AZM 161-B6L or AZM 161-B6R actuator.

#### Straight actuator B1

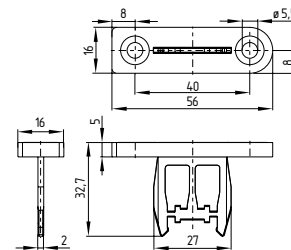

#### B1-1747 Straight design with magnetic latch

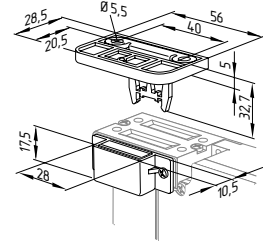

#### Straight actuator B1E

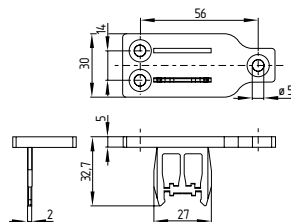

#### Actuator B1-2024 with slot lip-seal

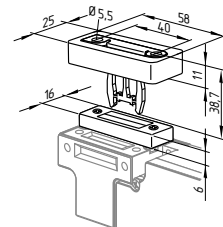

Flexible actuator B6L

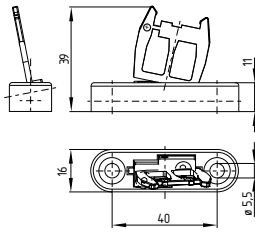

Flexible actuator B6R

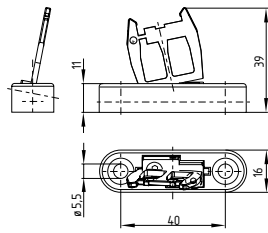

Actuator B1-2053  
with ball latch

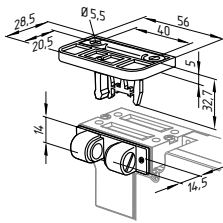

Actuator B1-2177 with centering  
guide

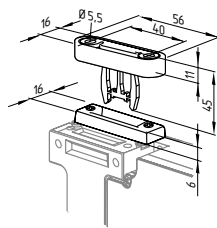

When the switch is fitted on a hinged safety guard, please ensure that the point of rotation is located within the range of the upper surface of the safety switch, in which the actuator hook is inserted (refer to table).

Actuating radii				
	$R_{min}$ [mm]	d [mm]	$R_{min}$ [mm]	d [mm]
<b>AZM 161-B6L</b>	95	11	95	11
<b>AZM 161-B6R</b>	95	11	95	11



### Key

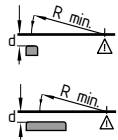

Actuating radius over the small edge of the actuator

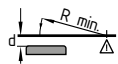

Actuating radius over the wide edge of the actuator

The axis of the hinge must be d mm above and in a parallel plane to the top surface of the safety switch. The basis setting provides a minimum radius of  $R_{min}$ .

### Setting screw

The AZM 161-B6L or AZM 161-B6R actuator is set to the smallest radius in factory. To increase the radius, the setting screws a + b must be turned by means of a hexagonal key A/F 2.0 mm.

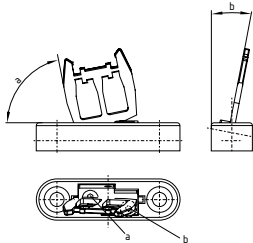

Strength of the actuator screws 5.6.

## 4. Electrical connection

### 4.1 General information for electrical connection



The electrical connection may only be carried out by authorised personnel in a de-energised condition.



If the risk analysis indicates the use of a monitored interlock they are to be connected in the safety circuit with the contacts indicated with the symbol

The contact labelling can be found in the wiring compartment of the switch.



Only use Ex cable glands and Ex blanking plugs with integrated or associated seals which are authorised for the corresponding field of application. The cable glands must be fitted in accordance with the applicable operating instructions manual. Cable glands are only authorised for permanent cables. The constructor must provide for the necessary strain relief. Unused cable entries must be sealed by means of Ex approved blanking plugs. Cable glands and blanking plugs are included in the delivery.



Puncturing the wall of the holes with auxiliary tools (e.g. screwdriver) can cause damage.

### Settle length x of the conductor:

- on cage clamps (CC) of type s or f: 5 ... 6 mm
- on screw terminals (SK): 7 mm



### 4.2 Contact Options

Contact variants are shown in a de-energised condition with actuator inserted.

#### Power to unlock

**EX-AZM 161SK-12/12..-024-3D**

**EX-AZM 161CC-12/12..-024-3D**

#### Power to lock

**EX-AZM 161SK-12/12..A-024-3D**

**EX-AZM 161CC-12/12..A-024-3D**

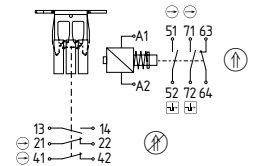
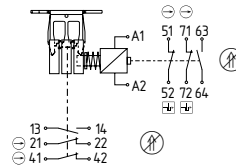

13 14 21 22 41 42 51 52 63 64 71 72 A1 A2 13 14 21 22 41 42 51 52 63 64 71 72 A1 A2

### Key

- Positive break NC contact
- Monitoring the interlock according to EN ISO 14119
- Actuated
- Not actuated



Information for the selection of suitable safety-monitoring modules can be found in the Schmersal catalogues or in the online catalogue on our website: [products.schmersal.com](http://products.schmersal.com).

## 5. Set-up and maintenance



The installation, operation and maintenance must be executed by qualified professionals. The requirements to be met for the installation and the maintenance can be found in this operating instructions manual. Do not expose the device to mechanical and/or thermal loads or stresses, which exceed the limits specified in the operating instructions manual.

For the set-up and the operation of the safety switchgear, the applicable (also national) safety and accident prevention regulations as well as the generally acknowledged codes of practice of technology must be observed.

### 5.1 Functional testing

The safety function of the safety components must be tested. The following conditions must be previously checked and met:

- The installation is executed according to the instructions
- The connection is executed correctly
- The cable is correctly executed and connected
- The safety component is not damaged
- Remove particles of dust and soiling.
- Check cable entry and connections.

### 5.2 Maintenance

A regular visual inspection and functional test, including the following steps, is recommended:

1. Check the correct fixing of the actuator and the safety switchgear
2. Remove particles of dust and soiling
3. Check cable entry and connections in a de-energised condition



Caution: avoid electrostatic charging. Clean with damp cloth. Do not open the device when live.



Adequate measures must be taken to ensure protection against tampering either to prevent tampering of the safety guard, for instance by means of replacement actuators.

**For explosion protection reasons, the component must be exchanged after max. 1 million operations.**

**Damaged or defective components must be replaced.**

## 6. Disassembly and disposal

### 6.1 Disassembly

The safety switchgear must be disassembled in a de-energised condition only.

### 6.2 Disposal



The safety switchgear must be disposed of in an appropriate manner in accordance with the national prescriptions and legislations.

## 7. EU Declaration of conformity

We declare under our sole responsibility that the products mentioned comply with all relevant provisions of the directives and regulations listed below and conform to the following standards.

### Relevant Directives:

**CE**  
2006/42/EC  
2014/30/EU  
2014/34/EU  
2011/65/EU

### Applied standards:

EN 60947-5-1:2017 + AC:2020  
EN ISO 14119:2013  
EN IEC 60079-0:2018  
EN 60079-31:2014



The currently valid declaration of conformity can be downloaded from the internet at [products.schmersal.com](http://products.schmersal.com).

**K.A. Schmersal GmbH & Co. KG**  
Mödinghofe 30, 42279 Wuppertal  
Germany  
Phone: +49 202 6474-0  
Telefax: +49 202 6474-100  
E-Mail: [info@schmersal.com](mailto:info@schmersal.com)  
Internet: [www.schmersal.com](http://www.schmersal.com)